

BL202 EtherCAT Distributed I/O



BL202 User Manual

Version: V1.2

Date: 2023-10-24

Shenzhen Beilai Technology Co.,Ltd

Website: <https://www.bliiot.com>

Preface

Thanks for choosing BLIIoT Distributed I/O. These operating instructions contain all the information you need for operation of BL202.

Copyright

This user manual is owned by Shenzhen Beilai Technology Co., Ltd. No one is authorized to copy, distribute or forward any part of this document without written approval of Shenzhen Beilai Technology. Any violation will be subject to legal liability.

Disclaimer

This document is designed for assisting user to better understand the device. As the described device is under continuous improvement, this manual may be updated or revised from time to time without prior notice. Please follow the instructions in the manual. Any damages caused by wrong operation will be beyond warranty.

Revision History

Update Date	Version	Description	Owner
2021-10-13	V1.0	First Edition	ZLF
2022-07-01	V1.1	Add Profinet, EtherCAT protocol, add platform, logic control functions	HYQ
2023-07-27	V1.1	Change Model name	HYQ
2023-10-24	V1.2	Add BL203, BL206, BL207 description	HYQ
2023-10-24	V1.2	User manual split by model	HYQ

Content

1	Product Introduction	5
1.1	Overview	5
1.2	Typical Application	6
1.3	Features	6
1.4	Model List.....	6
2	Hardware	8
2.1	I/O Coupler	8
2.2	Dimension	8
2.3	Data Contacts/Internal Bus	9
2.4	Power Jumper Contacts	10
2.5	Terminal Point	11
2.6	Electrical Schematic	12
3	Installation	12
3.1	Installation Sequence	12
3.2	Install Coupler	12
3.3	Remove Coupler	13
3.4	Insert I/O Modules	14
3.5	Remove I/O Modules	15
4	Device Connection	15
4.1	Wiring	15
4.2	Power Supply	16
4.2.1	System Power	16
4.2.2	On-site Power Supply	17
4.2.3	Grounding	18
5	BL202 EtherCAT Coupler	18
5.1	BL202 Coupler Overview	18
5.2	Technical Parameters	19
5.3	Hardware Interface	20
5.3.1	LED Indicators	20

5.3.2 Ethernet Port.....	21
5.3.3 IP Address Selection Switch.....	22
5.4 Process Data Definition.....	22
5.5 Coupler Connection.....	24
6 BL202 Communication Example.....	25
6.1 TwinCAT 3 and BL202 Communication.....	25
6.2 Omron NX1P2 and BL202 Communication.....	32
7 Warranty.....	41
8 Technical Support.....	41

1 Product Introduction

1.1 Overview

BL202 coupler is a data acquisition and control system based on a powerful 32-bit microprocessor design with a Linux operating system.

The BL202 distributed I/O system consists of 3 parts: Coupler, I/O modules and terminal modules.

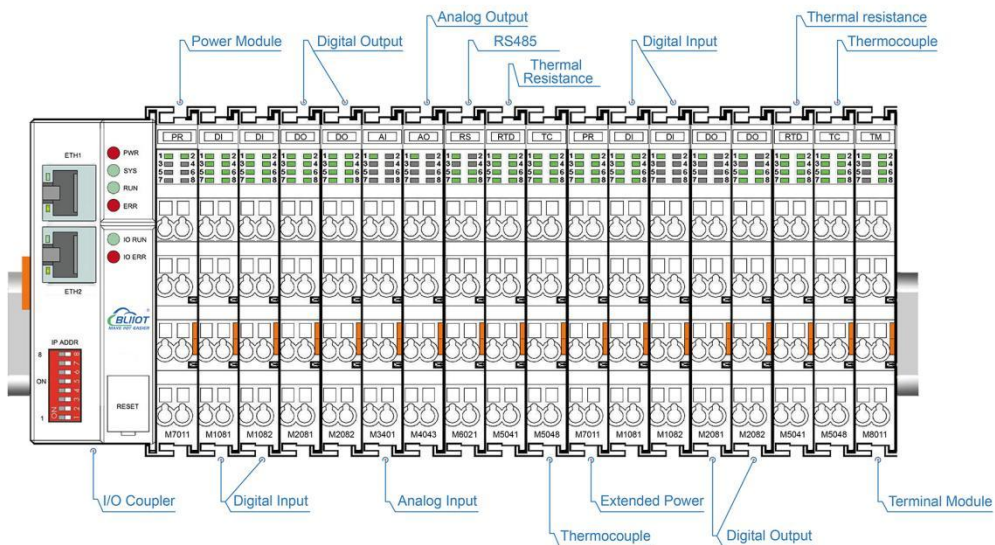

The communication between the node and the field devices (eg PLC) takes place via the Ethernet interface of the fieldbus coupler, and the communication between the fieldbus coupler and the I/O modules takes place via the local bus. The two Ethernet interfaces are internally integrated with a switch function, which can establish a linear topology without the need for additional switches or hubs.

The system needs to use the power module to provide 24VDC system voltage and 24VDC field voltage. Since two independent power supplies are used, the field voltage input interface and system voltage input interface of BL202 couplers are electrically isolated from each other.

When assembling fieldbus node modules, each I/O module can be arranged in any combination, and it is not required to be grouped by module type.

A terminal module must be plugged into the end of a fieldbus node to ensure correct data transmission.

1.2 Typical Application

High reliability, easy expansion, easy setting, and convenient network wiring, these capabilities let users efficiently adapt the BL202 I/O system to a variety of complex industrial applications.

1.3 Features

- Each I/O system can have a maximum of I/O 32 modules.
- Support connecting to EtherCAT master station.
- The field side, the system side and the bus side are electrically isolated from each other.
- Support 2 X RJ45 interface, integrated switch function, can establish line topology, without the need for additional switches or hubs.
- Convenient wiring connection technology, screw-free installation.

1.4 Model List

Description	Model	Channel	Type
Modbus-TCP I/O Coupler	BL200	/	/
Profinet I/O Coupler	BL201	/	/
EtherCAT I/O Coupler	BL202	/	EtherCAT
Ethernet/IP I/O Coupler	BL203	/	/
OPC UA EdgeIO Controller	BL205	/	/
MQTT EdgeIO Controller	BL206	/	/
MQTT+OPC UA+Modbus TCP	BL206Pro	/	/
BACnet/IP I/O Coupler	BL207	/	/
BACnet/IP+MQTT+OPC UA	BL207Pro	/	/
8CH DI	M1081	8	NPN (low level trigger)
8CH DI	M1082	8	PNP (high level trigger)
16CH DI	M1161	16	NPN (low level trigger)
16CH DI	M1162	16	PNP (high level trigger)
4CH DO	M2044	4	Relay
8CH DO	M2081	8	PNP
8CH DO	M2082	8	NPN

16CH DO	M2161	16	PNP
16CH DO	M2162	16	NPN
4CH AI Single-Ended	M3041	4	0-20mA/4-20mA
4CH AI Single-Ended	M3043	4	0-5V/0-10V
4CH AI Differential	M3044	4	0-5V/0-10V
4CH AI Differential	M3046	4	±5V/±10V
4CH AO	M4041	4	0-20mA/4-20mA
4CH AO	M4043	4	0-5V/0-10V
4CH AO	M4046	4	±5V/±10V
2CH RTD	M5021	2	3Wire PT100
2CH RTD	M5022	2	3Wire PT1000
2CH RTD	M5023	2	4Wire PT100
2CH RTD	M5024	2	4Wire PT1000
4CH TC	M5048	4	TC(B/E/J/K/N/R/S/T)
2CH RS485	M6021	2	RS485
2CH RS232	M6022	2	RS232
1CH RS485, 1CH RS232	M6023	2	RS485+RS232
Power module	M7011	/	/
Terminal module	M8011	/	/

2 Hardware

2.1 I/O Coupler

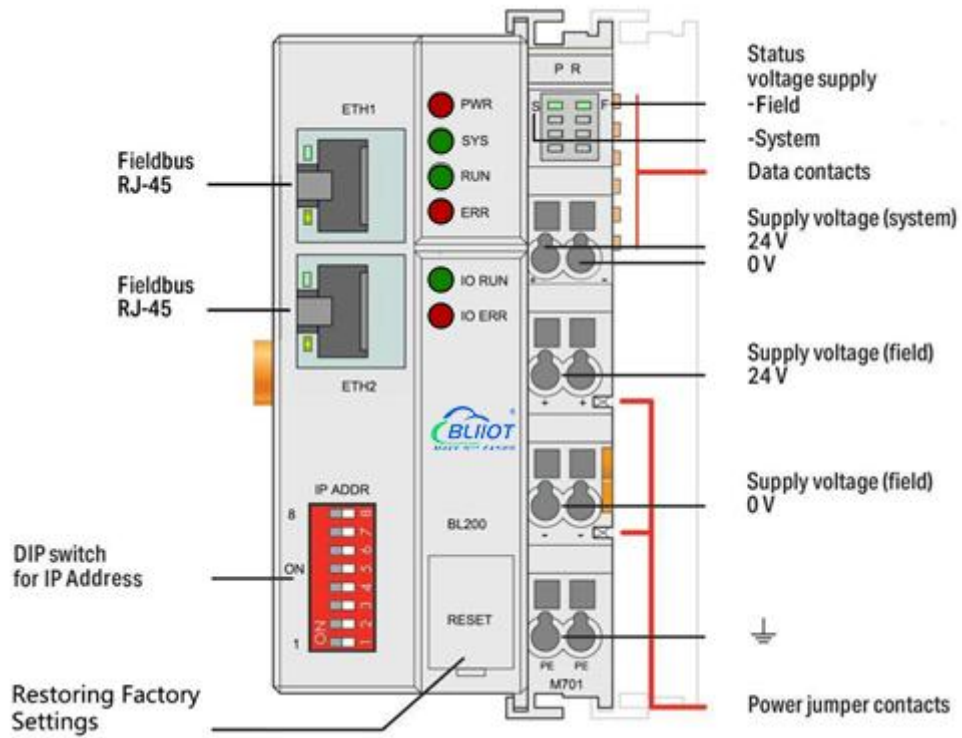

2.2 Dimension

Unit:mm

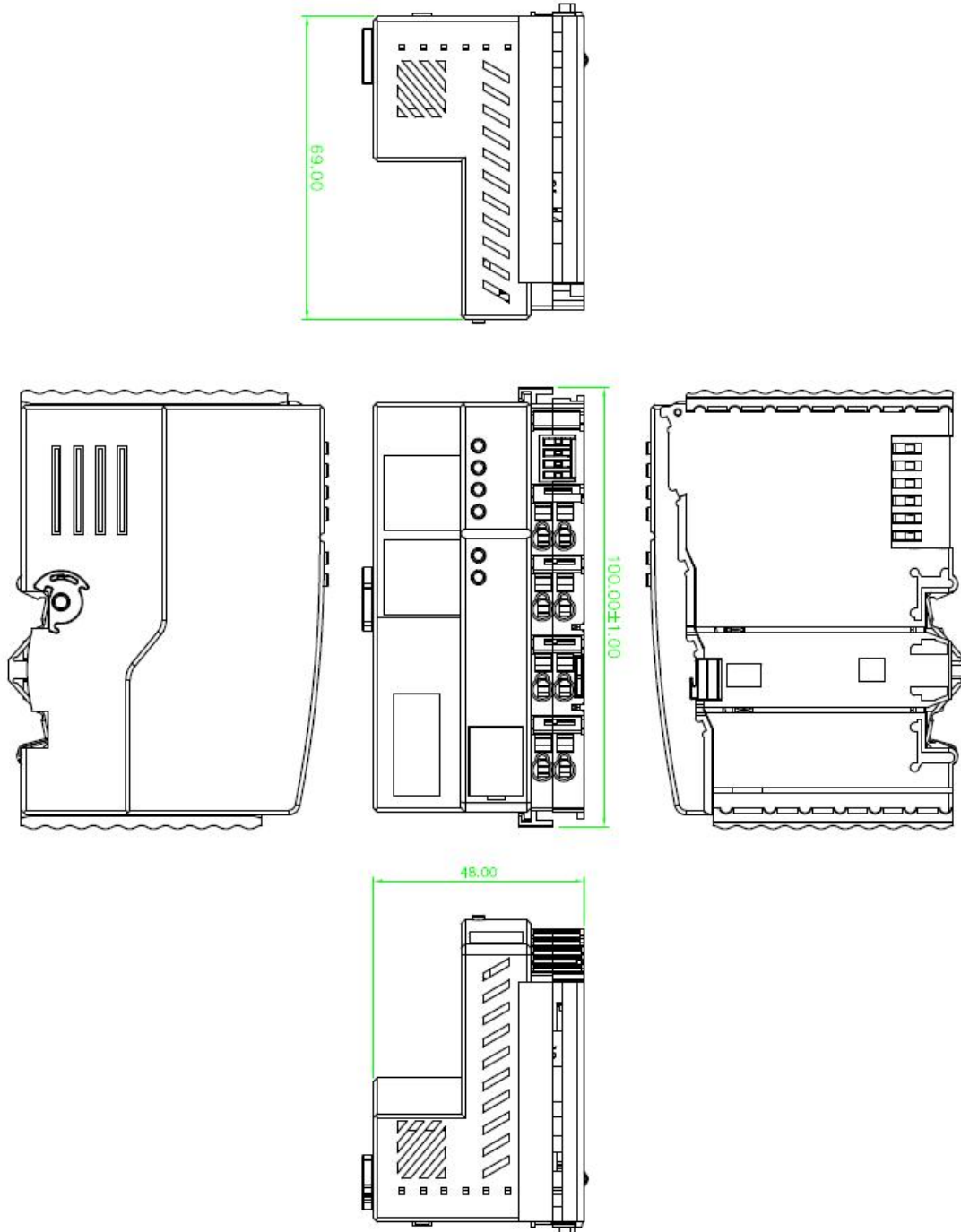

2.3 Data Contacts/Internal Bus

The communication between the fieldbus coupler/controller and the I/O modules, as well as the system power supply of the I/O modules are realized via the internal bus. The internal bus is made up of 6 data contacts, these gold-plated contacts are self-cleaning when connected.

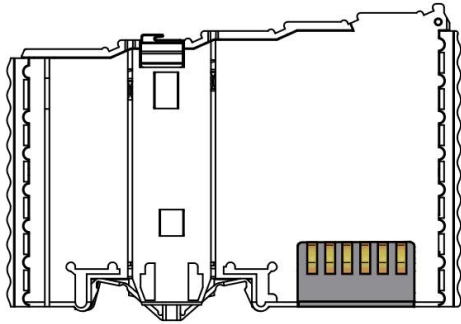

2.4 Power Jumper Contacts

The power module included with the coupler has two self-cleaning power jumper contacts for powering the field side. This power supply has a maximum current of 10A across the contacts, current exceeding the maximum will damage the contacts. When configuring the system, it must be ensured that the above-mentioned maximum current is not exceeded. If it exceeds, a power expansion module needs to be inserted.

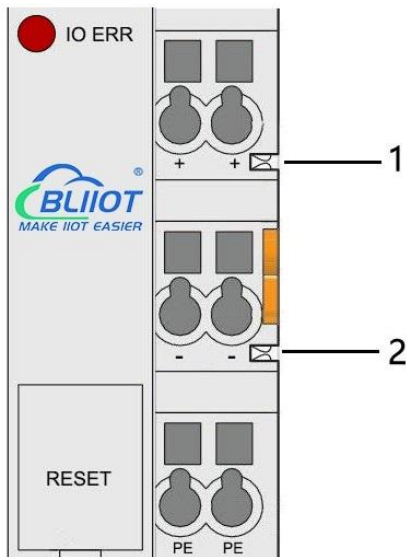

No.	Type	Description
1	Spring contact	Supply 24V to the field side
2	Spring contact	Supply 0V to the field side

2.5 Terminal Point

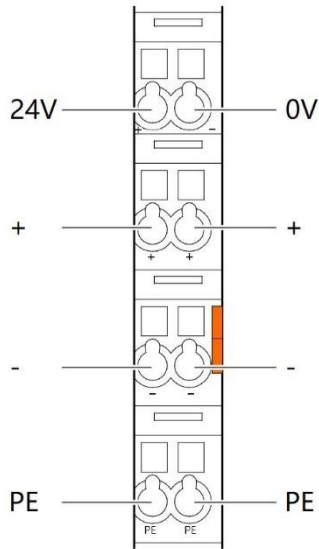

Name	Description
24V	System Power 24VDC
0V	System Power 0VDC
+	Connections Field Supply 24 VDC
+	Connections Field Supply 24 VDC
-	Connections Field Supply 0 VDC
-	Connections Field Supply 0VDC
PE	Grounding
PE	Grounding

2.6 Electrical Schematic

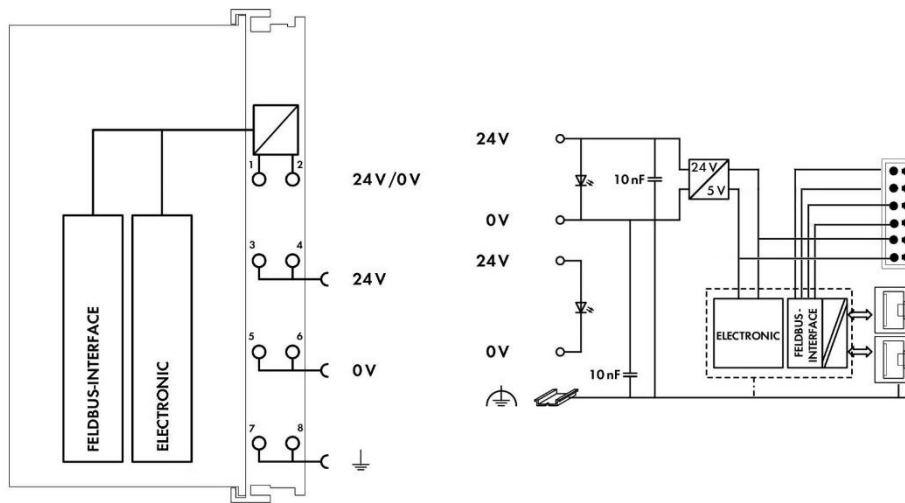

3 Installation

3.1 Installation Sequence

All distributed I/O couplers and I/O modules from Beilai Technology must be mounted on a standard DIN 35 rail.

Starting from the coupler, the I/O modules are assembled from left to right, and the modules are installed next to each other. All I/O modules have grooves and power jumper contacts on the right side, to avoid assembly errors, I/O modules must be inserted from the right and top to avoid damage to the modules.

Utilizes a tongue and groove system to form a secure fit and connection. With the automatic locking function, the individual components are securely fixed on the rail after installation.

Don't forget to install the terminal module! Always plug a terminal module (eg TERM) into the end of the I/O module to ensure correct data transmission.

3.2 Install Coupler

1. Snap the coupler onto the DIN rail first;
2. Use a tool such as a screwdriver to turn the locking cam until the locking cam engages the DIN rail.

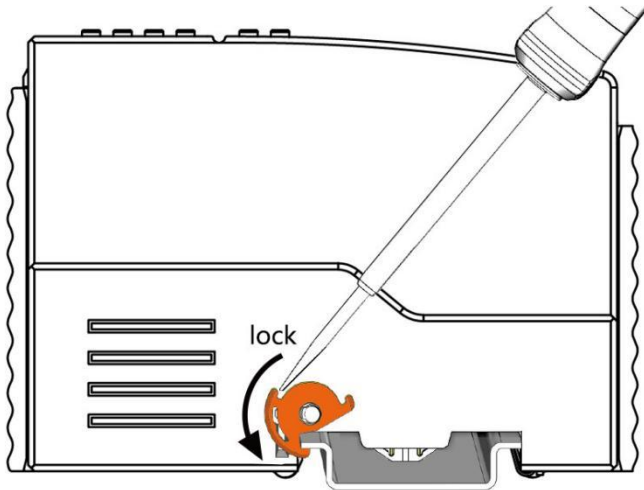

3.3 Remove Coupler

1. Use a screwdriver to turn the locking disc cam until the locking cam no longer engages the rail.

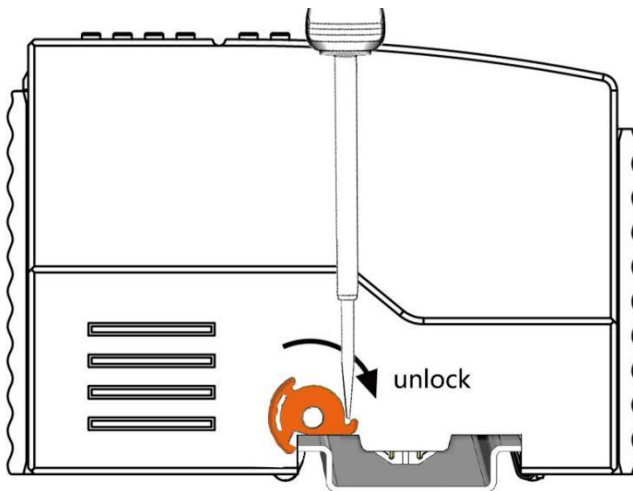

2. Pull the release tab to remove the coupler from the assembly

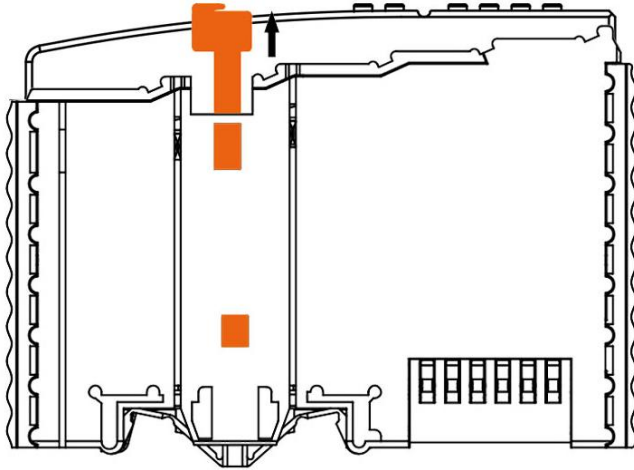

Data or power contacts are electrically disconnected from adjacent I/O modules when the coupler is removed.

3.4 Insert I/O Modules

1. When inserting the module, make sure the tabs on the module line up with the grooves of the coupler or other I/O module to which it is attached.



2. Press the I/O module into the assembly position until the I/O module snaps into the rail.

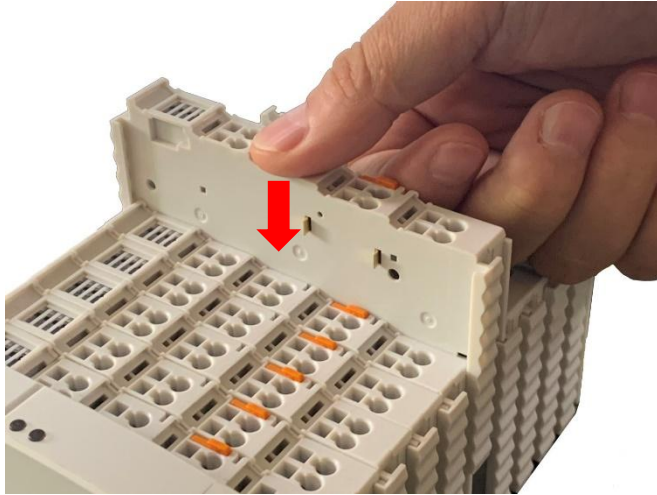

After the I/O module is installed, the electrical connection to the coupler (or the previous I/O module) and the following I/O module is established via the data contacts and the power jumper contacts.

3.5 Remove I/O Modules

Pull up on the latch to remove the I/O module from the assembly.

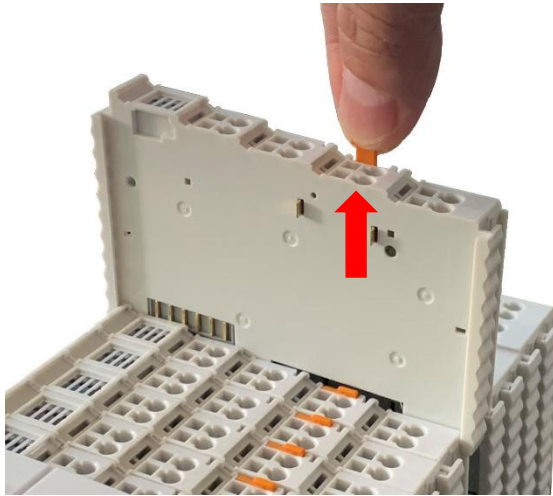

When the I/O module is removed, the electrical connection to the data or power jumper contacts is disconnection.

4 Device Connection

4.1 Wiring

CAGE CLAMP connection is suitable for solid, stranded and fine-stranded conductors. Only one wire can be connected to each CAGE CLAMP. If there is more than one wire,

it must be merged into a point before being connected.

1. Open the CAGE CLAMP by inserting the tool into the opening above the junction.
2. Insert the wire into the corresponding open connection terminal.
3. Once the tool is removed, the CAGE CLAMP closes and the wire is clamped firmly by the spring.

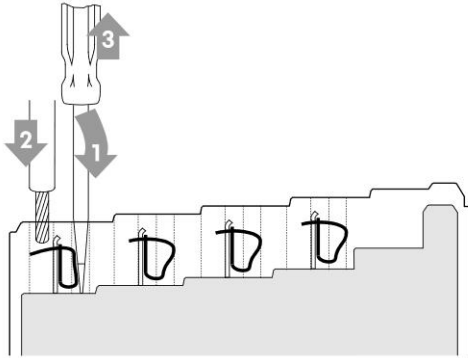

4.2 Power Supply

System and field voltages are supplied by power supply modules. The power supply module of the BL202 coupler supplies power for the internal electronics of the coupler and the I/O modules. If necessary (there are many I/O modules and the current is relatively high), it can also be provided through an independent power supply module. The fieldbus interface (Ethernet interface), system and field are galvanically isolated from each other.

4.2.1 System Power

BL202 coupler require 24V DC system power, which is connected from the terminal of the power supply module. The 5V bus voltage required inside the system is converted from the 24V system voltage.

The power supply module only has proper fuse protection, please provide proper overcurrent protection externally.

Please pay attention to matching the output power of the power supply module and the load power to avoid excessive load current.

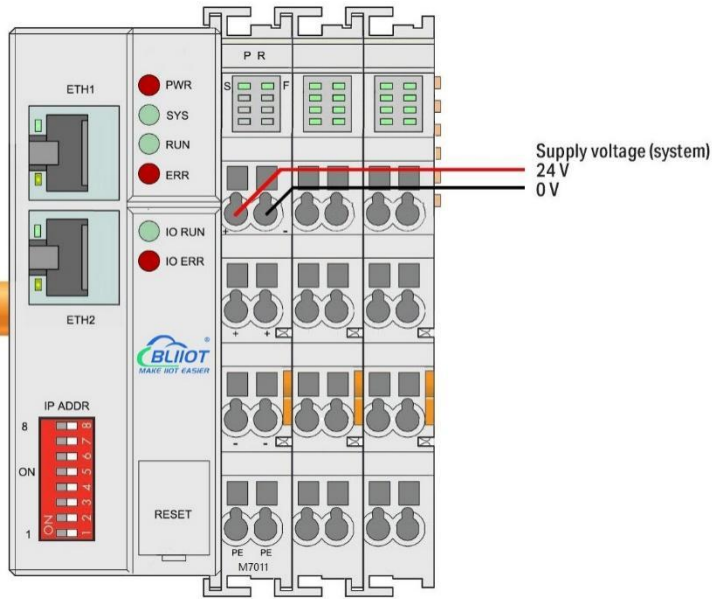

4.2.2 On-site Power Supply

The power supply module supplies 24 VDC on the field side to power the sensors and actuators.

Field power supply only has proper fuse protection. Without overcurrent protection, electronic equipment can be damaged.

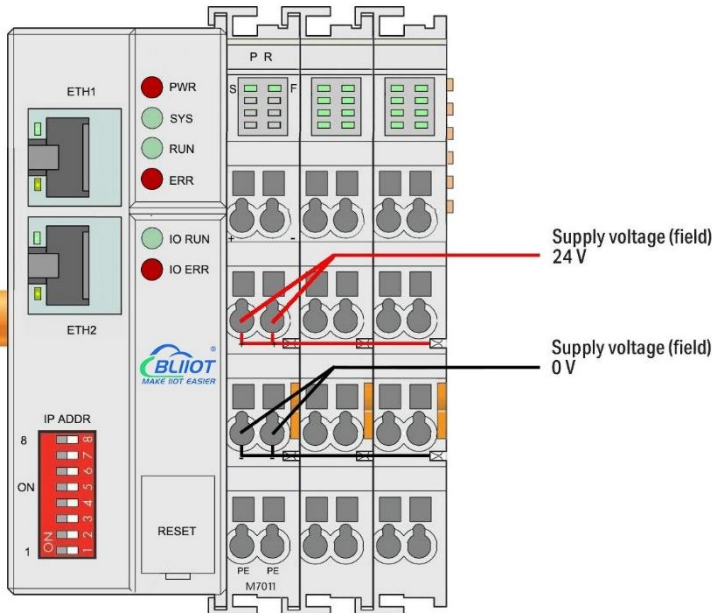

Field-side power is automatically output from the power jumper contact when the I/O module is connected. The continuous load current across the contacts of the power supply must not exceed 10 A.

The problem of excessive load power on the system side or on the field side can be

solved by plugging in additional power supply modules. After plugging in an additional power supply module, a new voltage potential may appear on the field side.

In the case where electrical isolation is not required, the field power supply and the system power supply can use the same power supply.

4.2.3 Grounding

When installing the enclosure cabinet, the cabinet must be grounded, and the rail is electrically connected to the cabinet through screws to ensure that the rail is properly grounded. Grounding can increase resistance to electromagnetic interference. Some components in the I/O system have rail contacts that dissipate EMI onto the rail.

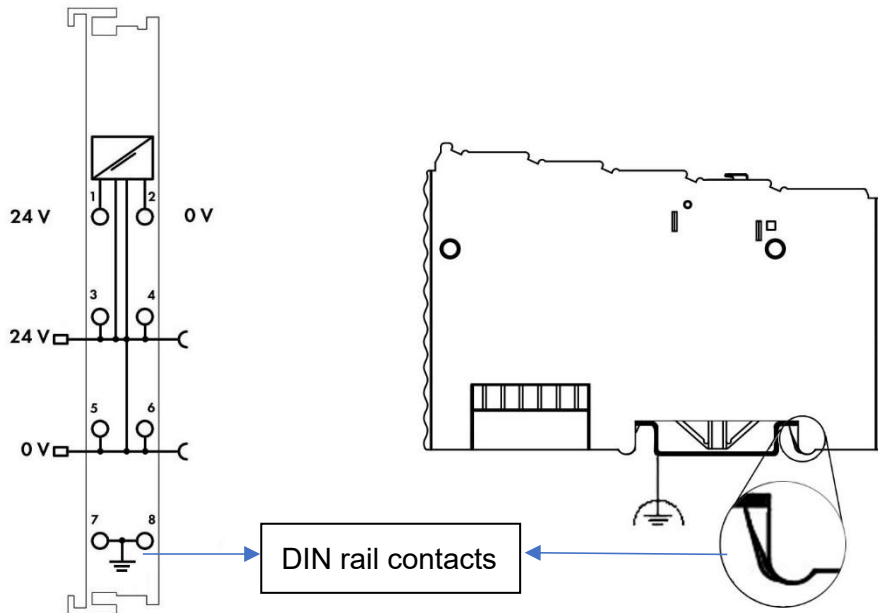

5 BL202 EtherCAT Coupler

5.1 BL202 Coupler Overview

The BL202 coupler supports standard EtherCAT protocol access. The coupler supports a maximum input of 1024 bytes, a maximum output of 1024 bytes, and supports 32 extended IO modules.

5.2 Technical Parameters

Name	Parameter	Description
System power	Input voltage(system)	24 VDC
	Input current(system)	MAX 500 mA@24VDC
	Power Efficiency	84%
	Internal bus voltage	5VDC
	Coupler current consumption	MAX 300mA@5VDC
	I/O current consumption	MAX 1700mA@5VDC
	Isolation protection	500 V system/supply
Field power	Input voltage (field)	24 VDC
	Current carrying capacity (power jumper contacts)	MAX 10 ADC
Ethernet	Number	2 X RJ45
	Transmission medium	Shielded twisted pair S/FTP, F/FTP or SF/FTP; 100 Ω, Cat 6
	MAX cable length	100m
	Baud rate	10/100 Mbit/s
	Isolation protection	ESD contact: 8KV, Surge: 4KV(10/1000us)
System	Operating system	Linux
	CPU	300MHz
	RAM	64MB
	Flash	128MB
	I/O Modules	MAX 32
	Protocol	EtherCAT
	Process data area	Input up to 1024 bytes, output up to 1024 bytes
Wiring method	Method	CAGE CLAMP
	Wire diameter	0.08 mm ² ... 2.5 mm ² , AWG 28 ... 14
	Strip length	8 mm ... 9 mm / 0.33 in
Environment	Working temperature	0 ... 55 ° C
	Storage temperature	-40 ... 70 ° C
	Relative humidity	5 ... 95% no condensation
	Working altitude	0 ... 2000 m
	Protection type	IP20

Dimension	Width	48mm
	Length	100mm
	Height	69mm
Material	Color	Light gray
	Shell material	Polycarbonate, Nylon 6.6
	Fire load	1.239 MJ
	Weight	180g
Installation	Method	DIN-35 rail
Certificates	EMC	EN 55022: 2006/A1: 2007 (CE &RE) Class B
		IEC 61000-4-2 (ESD) Level 4
		IEC 61000-4-3 (RS) Level 4
		IEC 61000-4-4 (EFT) Level 4
		IEC 61000-4-5 (Surge)Level 3
		IEC 61000-4-6 (CS)Level 4
		IEC 61000-4-8 (M/S) Level 4

5.3 Hardware Interface

5.3.1 LED Indicators

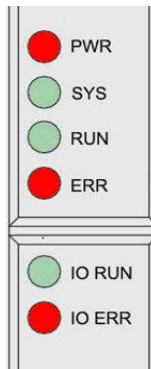

LED	Description	Color	Status	Meaning
PWR	Power indicator	Red	ON	Power connection successful
			OFF	No power
SYS	System indicator	Green	ON	EtherCAT OP Status
			Fast Flash	EtherCAT Bootstrap Status
			Slow flash	EtherCAT Pre-OP Status

			On and off alternately	EtherCAT Safe-OP Status
			OFF	EtherCAT Init Status
RUN	Running indicator	Green	Flashing	System is running normally
			OFF	System is abnormal
ERR	Error indicator	Red	ON	The coupler is abnormal
			OFF	No errors
I/O RUN	I/O Running indicator	Green	Flashing	I/O module is working normally
			OFF	Module not inserted
I/O ERR	I/O Error indicator	Red	ON	I/O module communication error
			OFF	No errors



LED	Description	Color	Status	Meaning
S	System 24V power indicator	Green	ON	Power is OK
			OFF	No power
F	Field 24V power indicator	Green	ON	Power is OK
			OFF	No power

5.3.2 Ethernet Port

Connect to the Ethernet-based field bus through ETH 1.

ETH2 is used to connect other nodes that need to access the Ethernet.

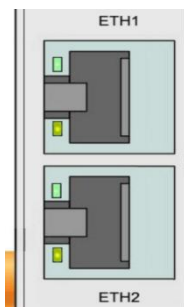

5.3.3 IP Address Selection Switch

It's not working on BL202 coupler.

5.4 Process Data Definition

BL202 does not support the data collected by the serial port module temporarily. The data point address of the I/O module is determined by the EtherCAT master station, and the data of AI and AO are mapped to 0-65535.

AO 0-5V/0-10V output value

Voltage(0-5V)	Voltage(0-10V)	Decimal	Hexadecimal
5	10	65535	0xFFFF
.	.	.	.
.	.	.	.
2.5	5	32767	0x7FFF
.	.	.	.
.	.	.	.
0	0	0	0x0000

If analog output 3V is required

When the range is 0-5V, send value $3 \times 65535 / 5 = 39321$

When the range is 0-10V, send value $3 \times 65535 / 10 = 19660.5$, because AO is an integer, then send down 19660.

AO -5-5V/-10-10V output value

Voltage(-5-5V)	Voltage(-10-10V)	Decimal	Hexadecimal
5	10	32767	0x7FFF
.	.	.	.
2.5	5	16383	0x3FFF
.	.	.	.
-2.5	-5	-16383	0xC001
.	.	.	.
-5	-10	-32767	0x8001

If analog output 3V is required

When the range is -5-5V, send value $3 \times 65534 / 10 = 19660.2$, because AO is an integer, then send 19660.

When the range is -10-10V, send value $3 \times 65534 / 20 = 9830.1$, because AO is an integer, then send 9830.

AO 0-20mA/4-20mA output value

Current(0-20mA)	Current(4-20mA)	Decimal	Hexadecimal
20	20	65535	0xFFFF
.	.	.	.
.	.	.	.
10	12	32767	0x7FFF
.	.	.	.
.	.	.	.
0	4	0	0x0000

If analog output 17mA is required

When the range is 0-20mA, send value $17 \times 65535 / 20 = 55704.75$, because the AO is an integer, then send 5570.

When the range is 4-20mA, send value $(17-4) \times 65535 / 16 = 53247.1875$, because the AO is an integer, then send 53247.

AI 0-20mA/4-20mA input value

Current(0-20mA)	Current(4-20mA)	Decimal	Hexadecimal
20	20	65535	0xFFFF
.	.	.	.
.	.	.	.
10	12	32767	0x7FFF
.	.	.	.
.	.	.	.
0	4	0	0x0000

Example: The AI value in the master station is 56789, then when the range is 0-20mA, the theoretical value of AI is: $56789 / 65535 / 20 = 17.33089\text{mA}$. When the range is 4-20mA, the theoretical value of AI is: $56789 / 65535 \times 16 + 4 = 17.86471\text{mA}$.

AI 0-5V/0-10V input value

Voltage(0-5V)	Voltage(0-10V)	Decimal	Hexadecimal
5	10	65535	0xFFFF
.	.	.	.
.	.	.	.

2.5	5	32767	0x7FFF
.	.	.	.
.	.	.	.
0	0	0	0x0000

Example: The value of AI displayed in the master station is 23456, then the theoretical value of AI for range 0-5V is $23456/65535*5=1.79V$. The theoretical value of AI for range 0-10V is $23456/65535*10=3.58V$.

AI -5-5V/-10-10V input value

Voltage(-5-5V)	Voltage(-10-10V)	Decimal	Hexadecimal
5	10	32767	0x7FFF
.	.	.	.
2.5	5	16383	0x3FFF
.	.	.	.
-2.5	-5	-16383	0xC001
.	.	.	.
-5	-10	-32767	0x8001

Example: The value of AI displayed in the master station is 23456, then the theoretical value of AI for range -5-5V is $23456/65534*10=3.579 V$. The theoretical value of AI for range -10-10V is $23456/65534*20=7.158V$.

5.5 Coupler Connection

The BL202 coupler is used as an EtherCAT slave, and is connected to the Ethernet-based fieldbus EtherCAT master through ETH 1 interface. ETH 1 can also be connected to the EtherCAT master through a switch, and ETH2 is used to connect other nodes that need to access Ethernet. The BL202 coupler does not have a separate web configuration interface.

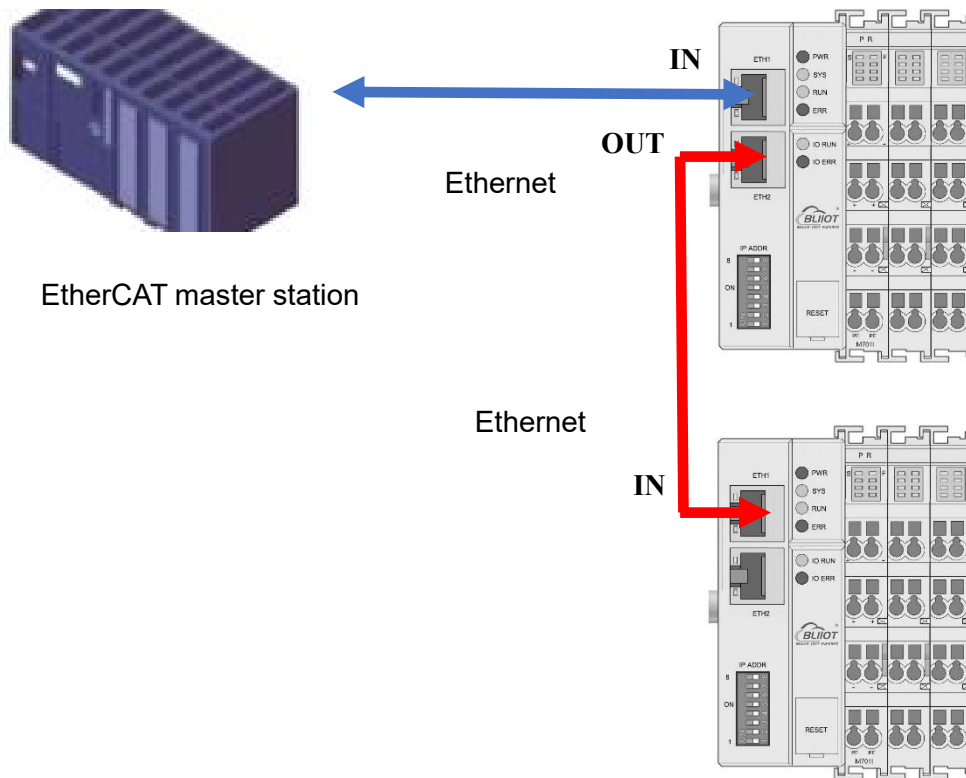

6 BL202 Communication Example

6.1 TwinCAT 3 and BL202 Communication

1. Prepare IO modules: Coupler BL202, digital output module M2082, digital input M1081, analog input module M3401, analog output M4043. Module assembly and wiring refer to chapter 3 Installation, chapter 4 Device connection.
2. Connect the Ethernet port ETH1 of the BL202 to the Ethernet port of the PC. Do not connect the Ethernet port of the BL202 wrongly, and power on the BL202 coupler.
3. Import the XML file

Copy the XML file (BL202-v1.01.xml) to: ...:\TwinCAT\3.1\Config\Io\EtherCAT, and load the XML to TwinCAT as shown in the figure below. Note: When the XML file in this folder is updated, you must re-click to download the device description file.

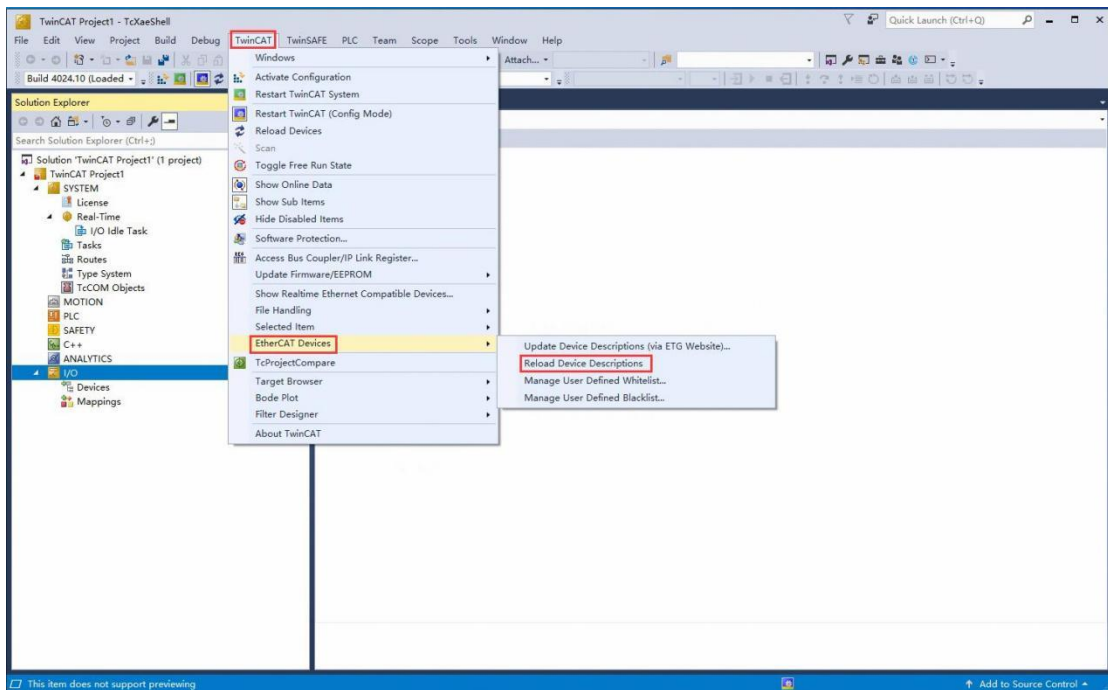
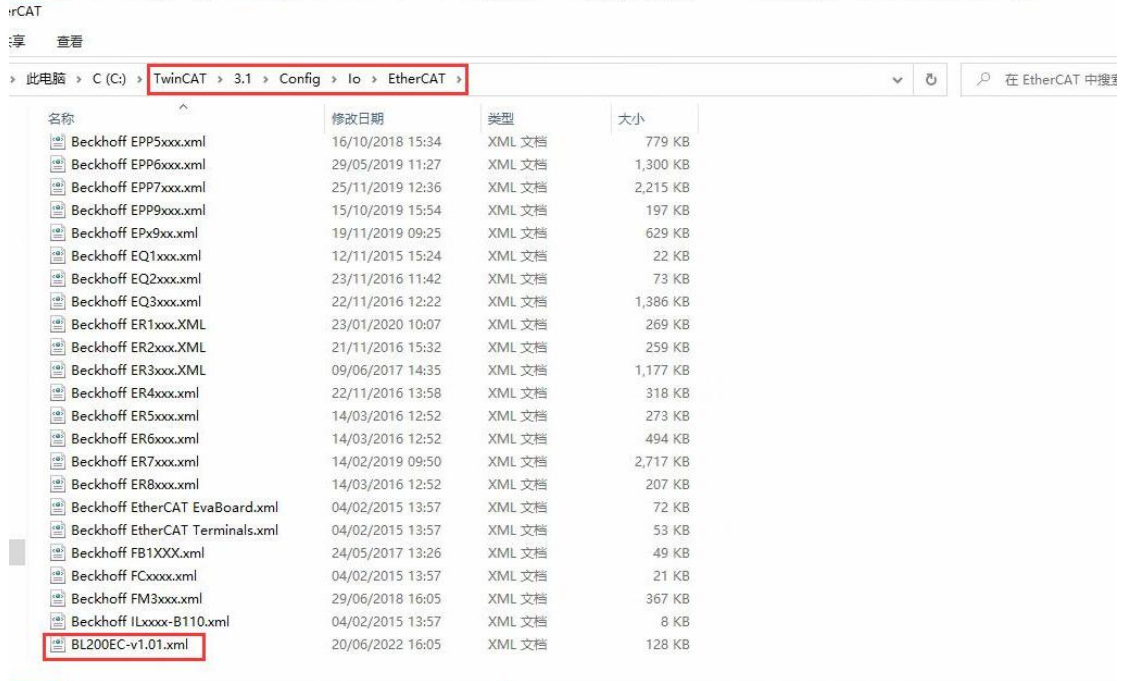

4. Open the TwinCAT XAE software, click [FILE] -> [New] -> [Project] in turn, and the interface as shown in the figure below will pop up.

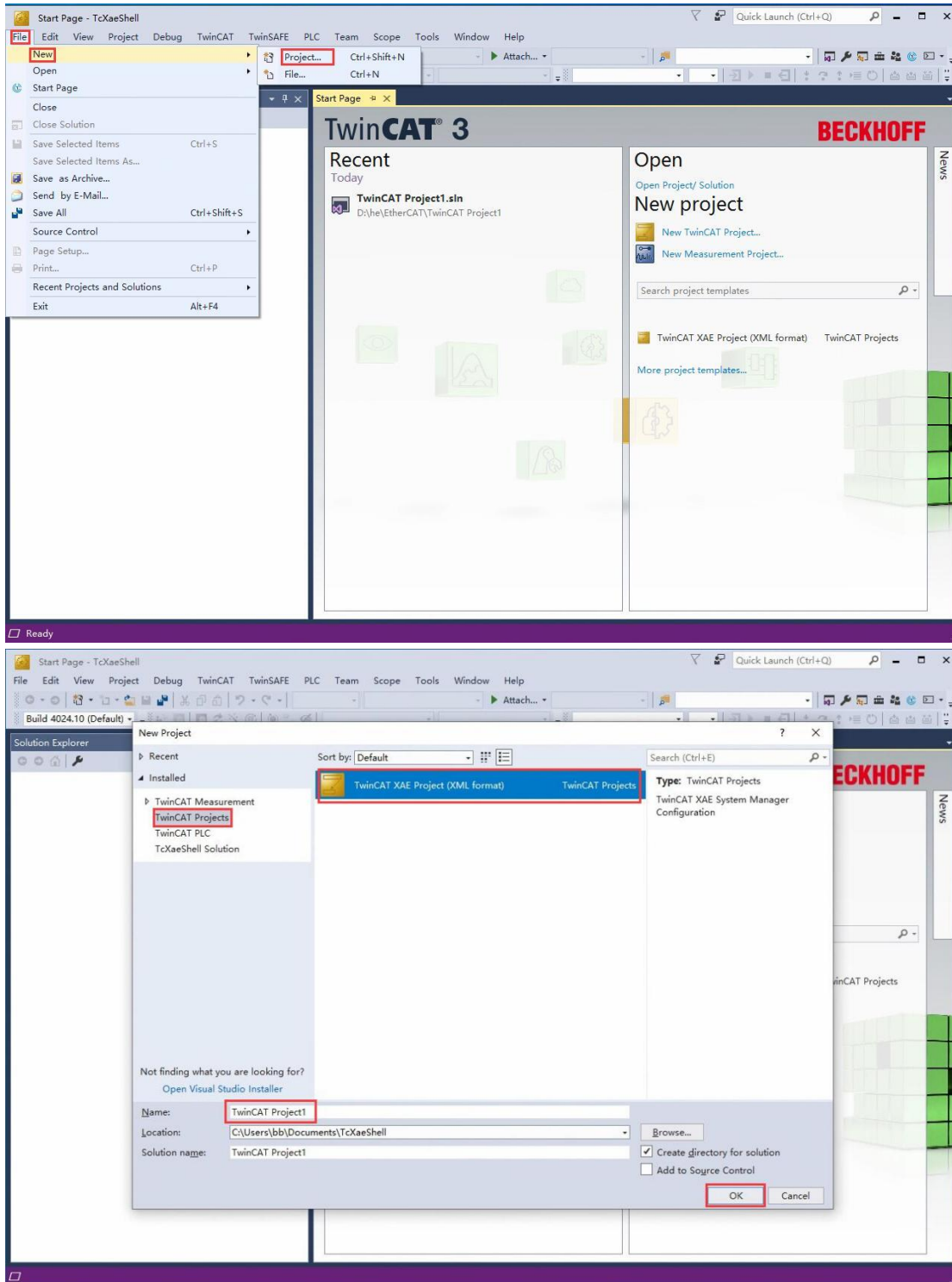

Select [TwinCAT Projects] as shown in the interface and select [TwinCAT XAE Project] in the middle of the interface, and keep the default (name, location, solution name can be modified according to needs), and click the [OK] button.

5. Scanning device

Click [I/O]->[Device]->[Scan], and click on the pop-up interface: OK—OK—Yes—Yes.

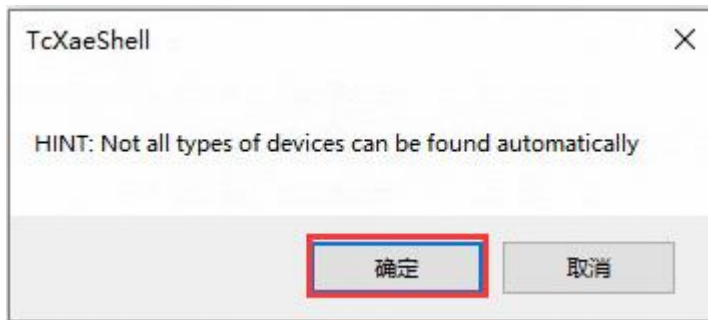
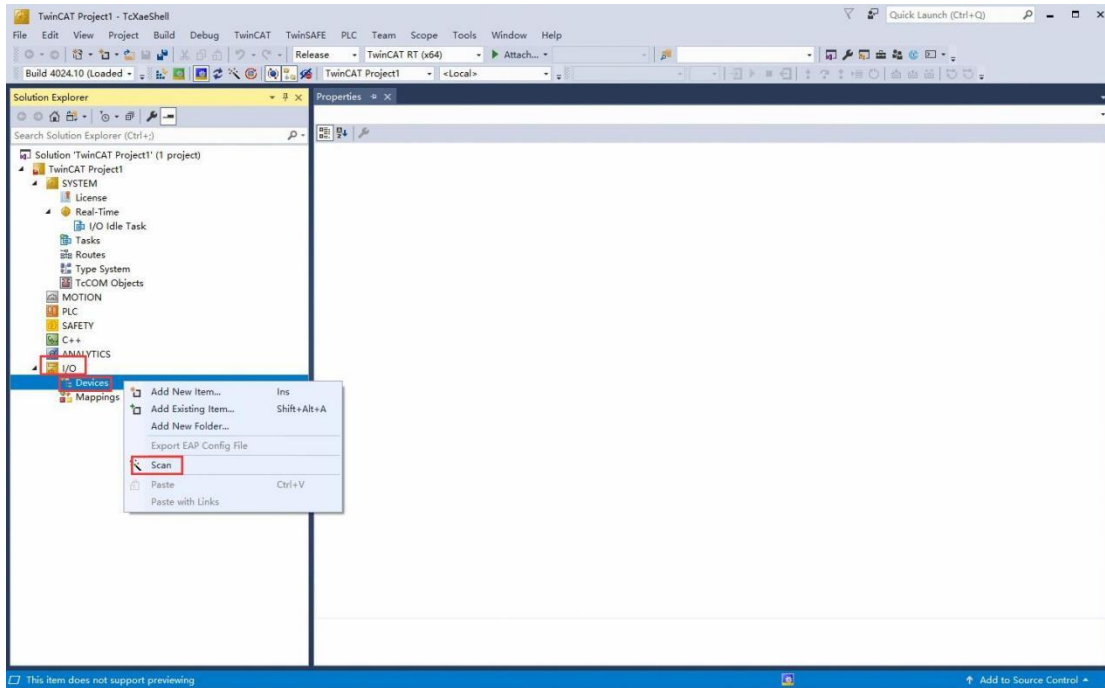

Check the "Local Area Connection" network card

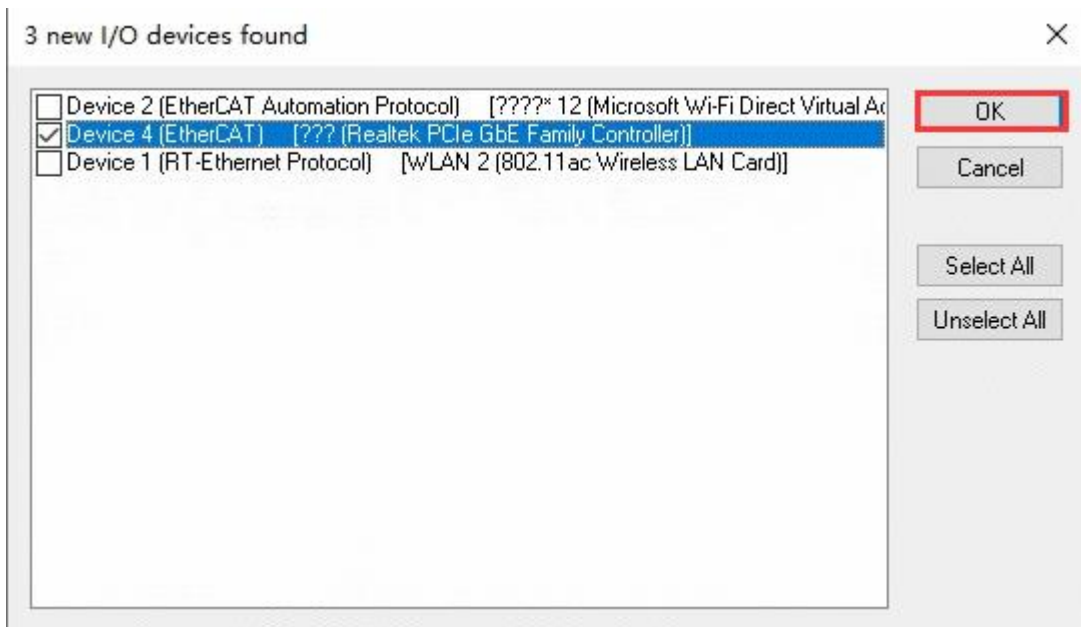

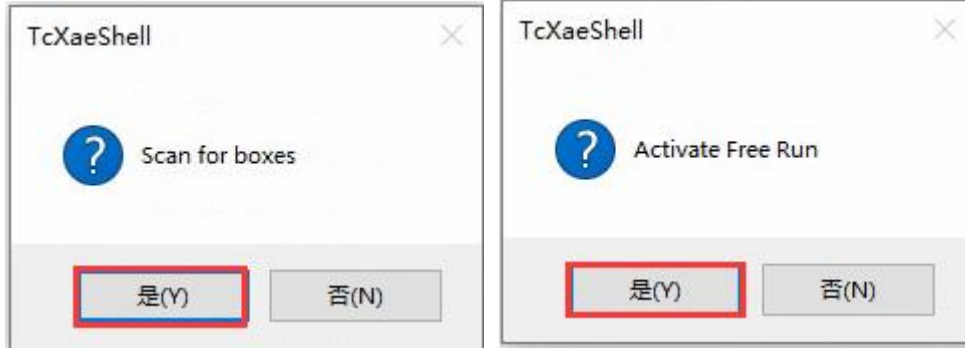

Scan to the Box1 (BL202) coupler, and the module information connected to the coupler is below Box1.

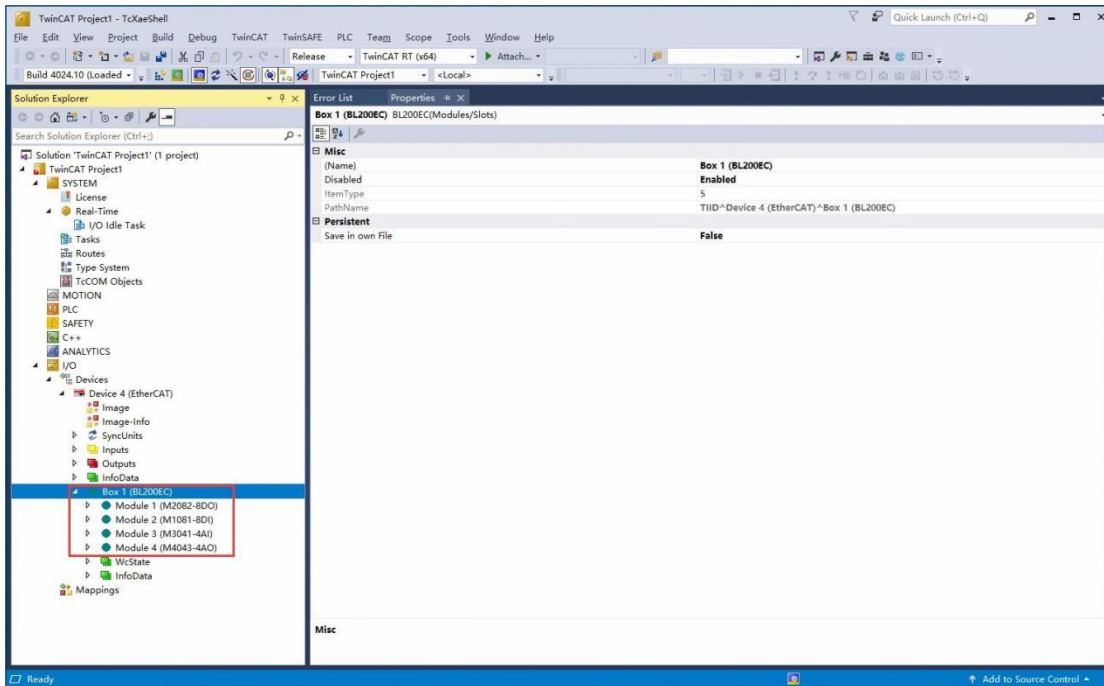

6. Data interaction

Check whether the BL202 coupler is in the OP state

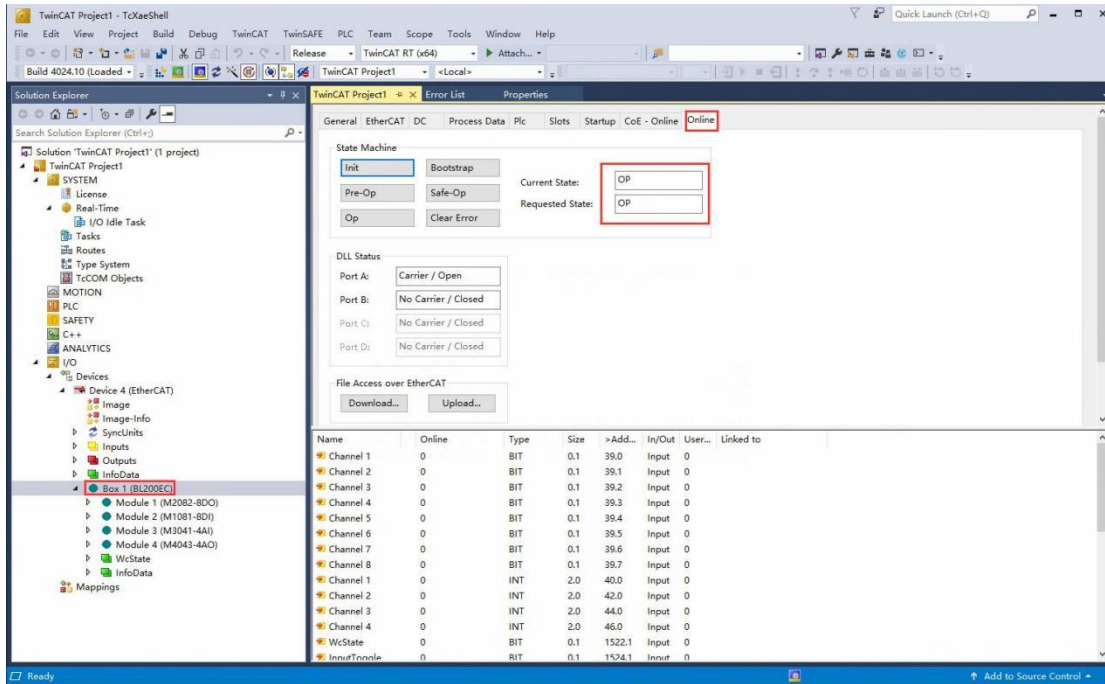

Digital output and analog output

Take M2082 as an example: To make channel 1 of the module output, click "Write" in the "Online" window corresponding to the module "Output[1]", and enter the value "1" in the "Dec" column of the dialog box. And click "OK", you can see that the channel indicator light corresponding to the module is on, and the software interface can display the written value at the same time. Similarly, the operation method of the analog AO output M4043 module is the same,

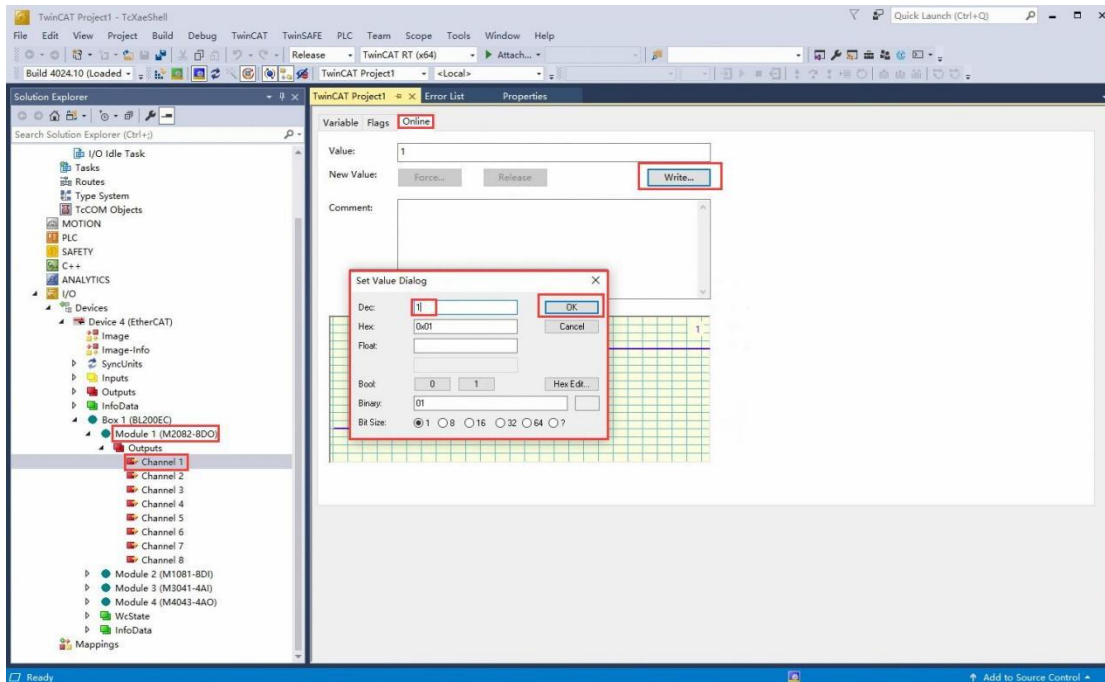

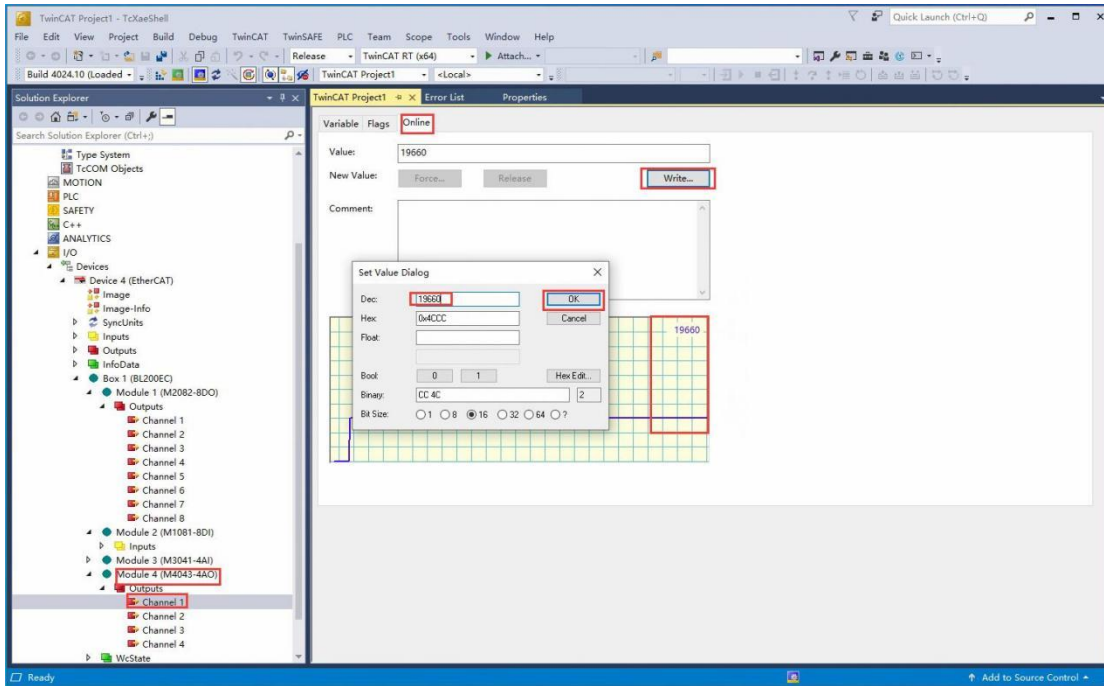

Digital and analog inputs

Take the M1081 module as an example: If the module has a signal input, it can be monitored in the "Inputs" of the module. Similarly, the viewing method of the analog AI input M3041 module is the same, as shown in the figure below:

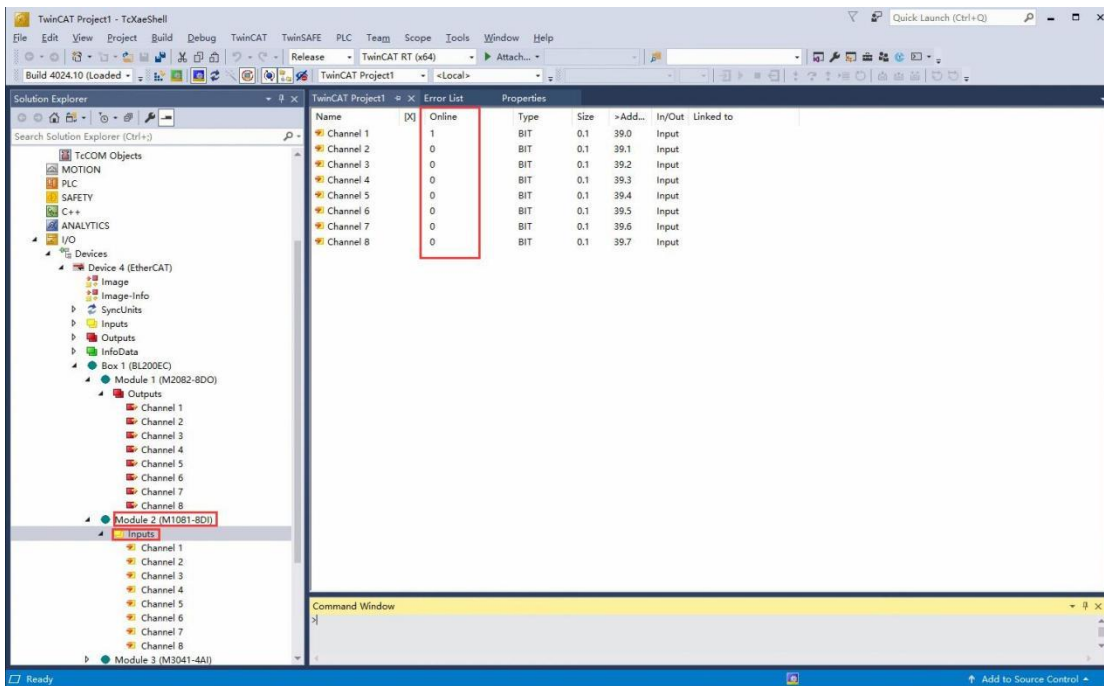

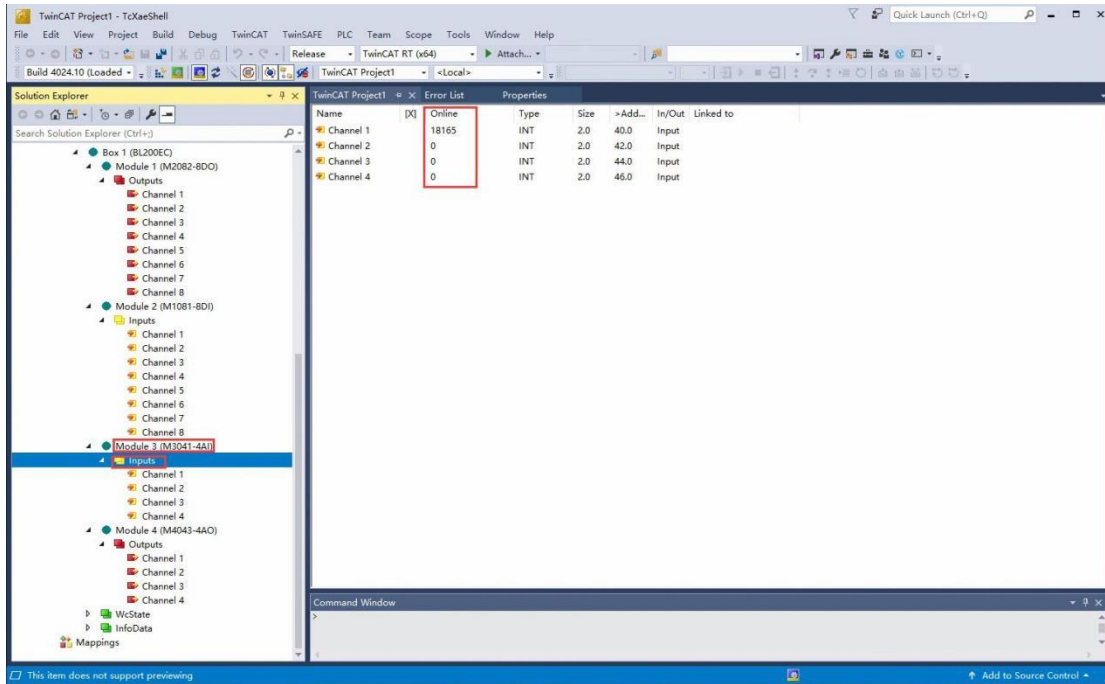

6.2 Omron NX1P2 and BL202 Communication

1. Port1 of Omron NX1P2 is connected to the network port of the computer, and Port2 is connected to the ETH1 Ethernet port of BL202. Power on Omron NX1P2 and BL202.
2. Open the Sysmac Studio software, create a new project, select NX1P2-9024DT, and click Create.

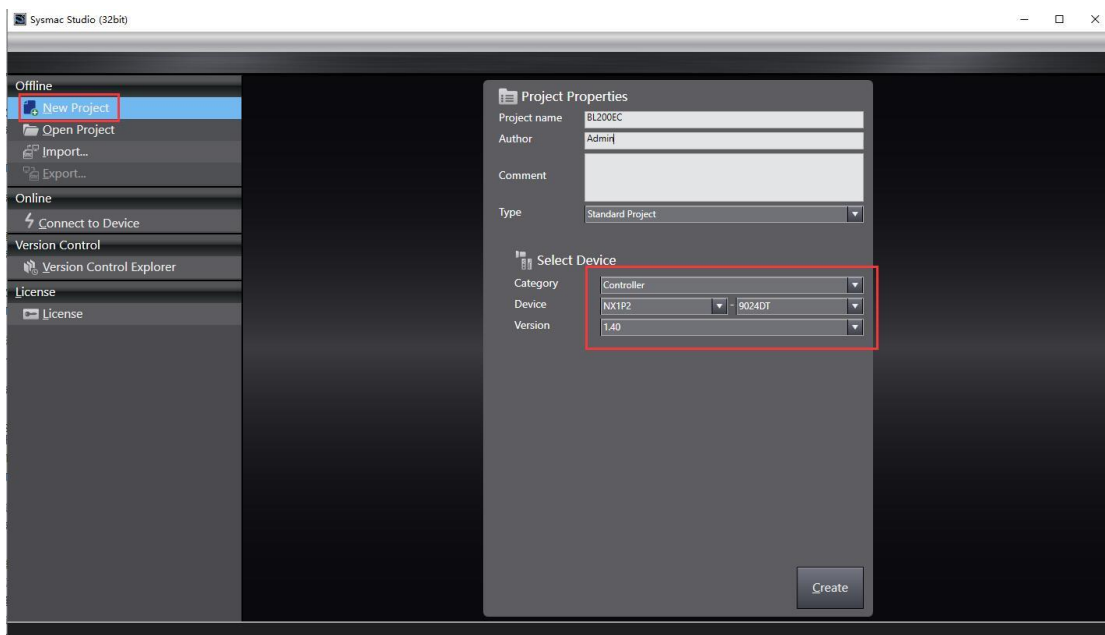

3. Click Configuration and Setup - Controller Setup - Built-in EtherNet/IP Port Setup to

view the fixed IP address.

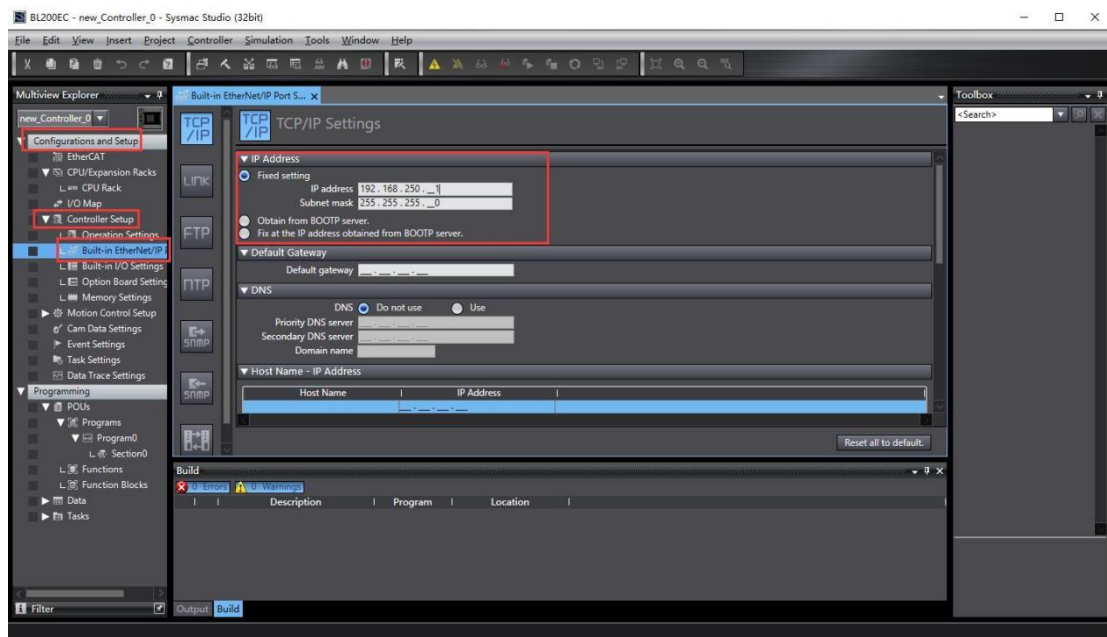

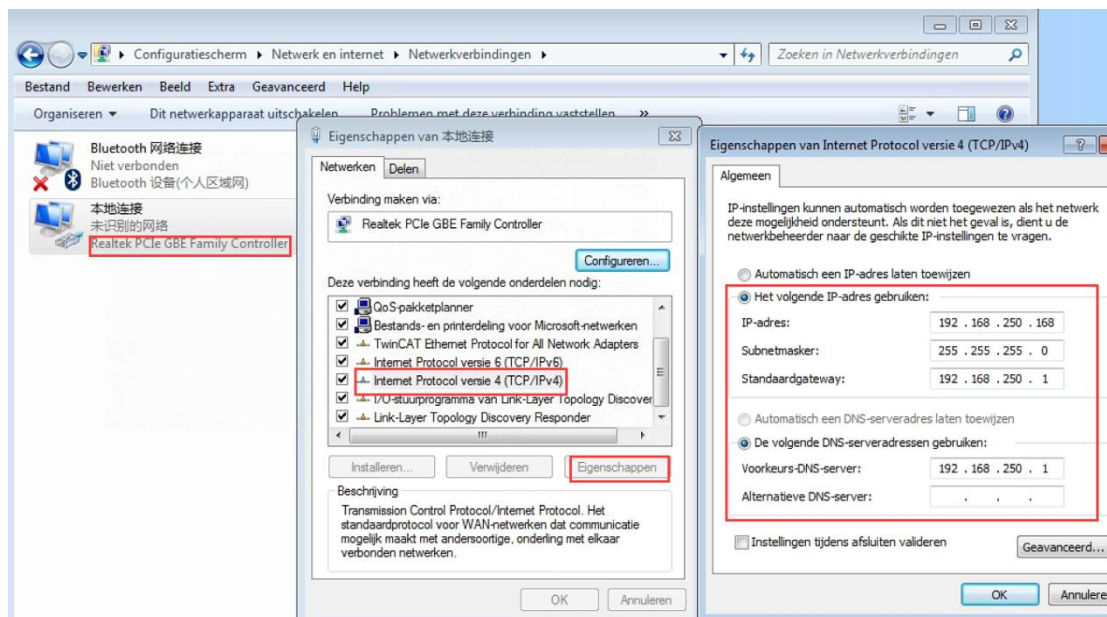

4. Set the computer IP and PLC in the same network segment.

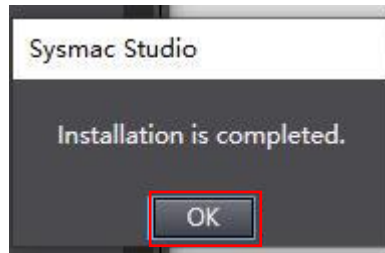
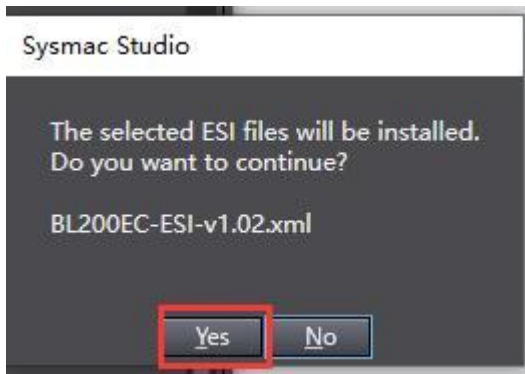
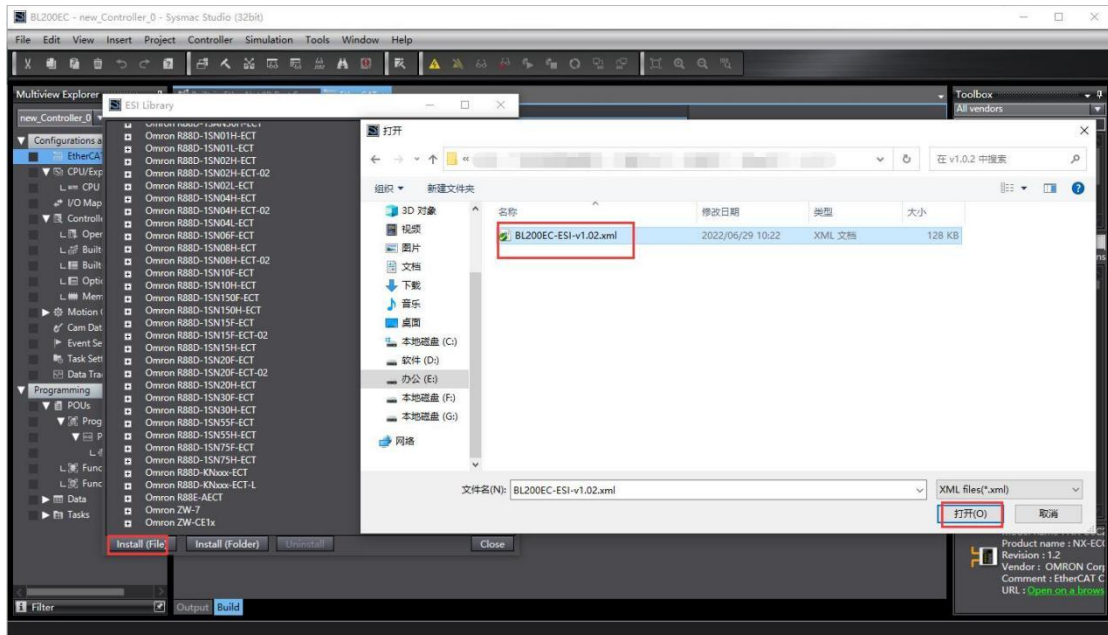
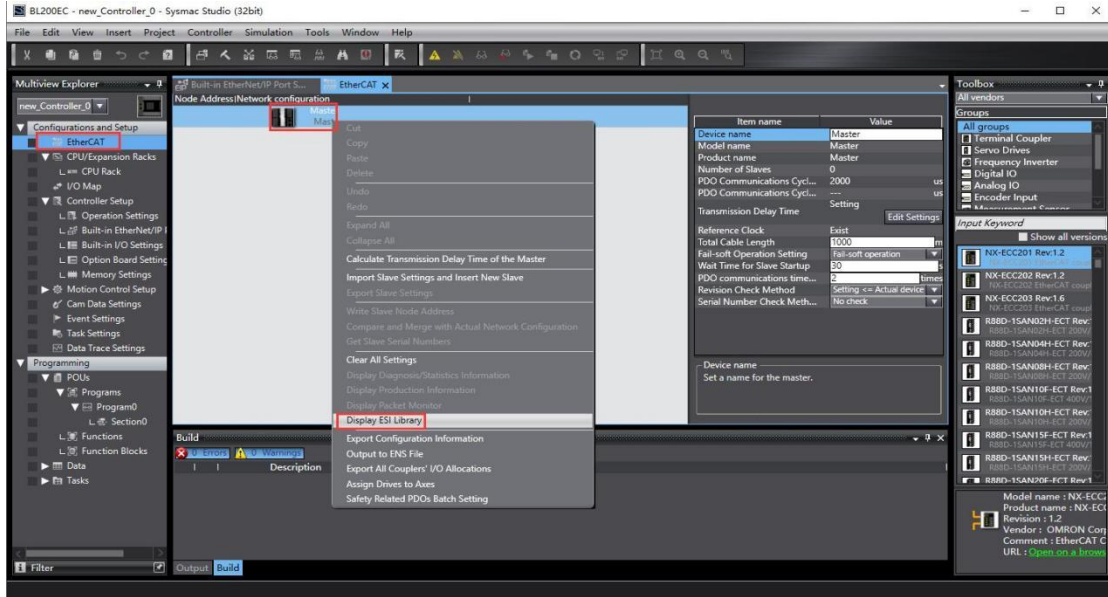

5. Double-click EtherCAT, right-click on the main device on the right side to display the ESI library, click the installation file in the pop-up window, find the BL202-ESI XML file, click Open, click Continue to install the XML file, and the installation is complete. You can see the newly installed BL202 at the bottom of the ESI library.

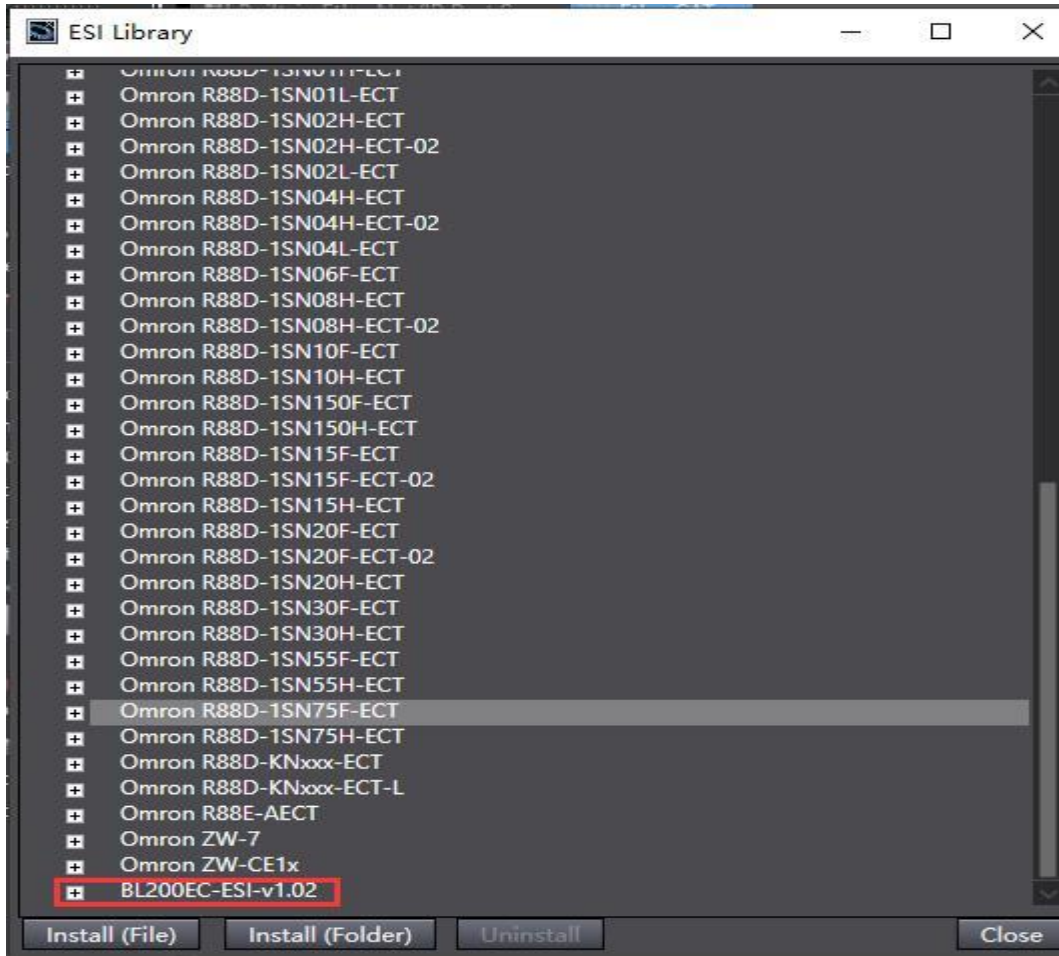



6. Click Controller—Online, or click the shortcut icon 

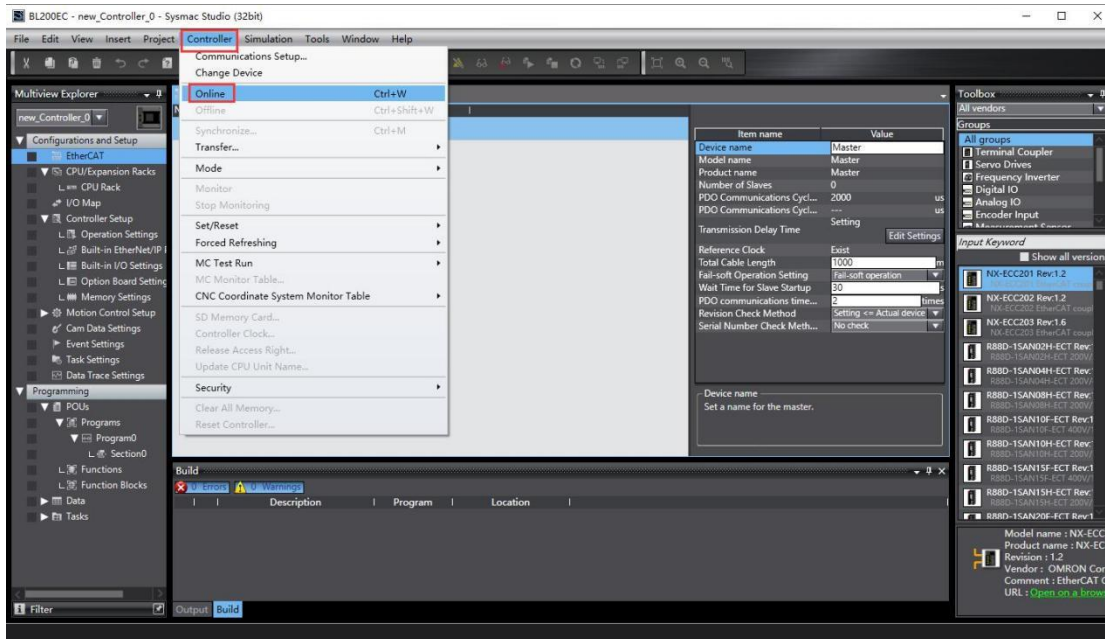

7. Write BL202 node address. After writing successfully, BL202 needs to be powered off and restarted.

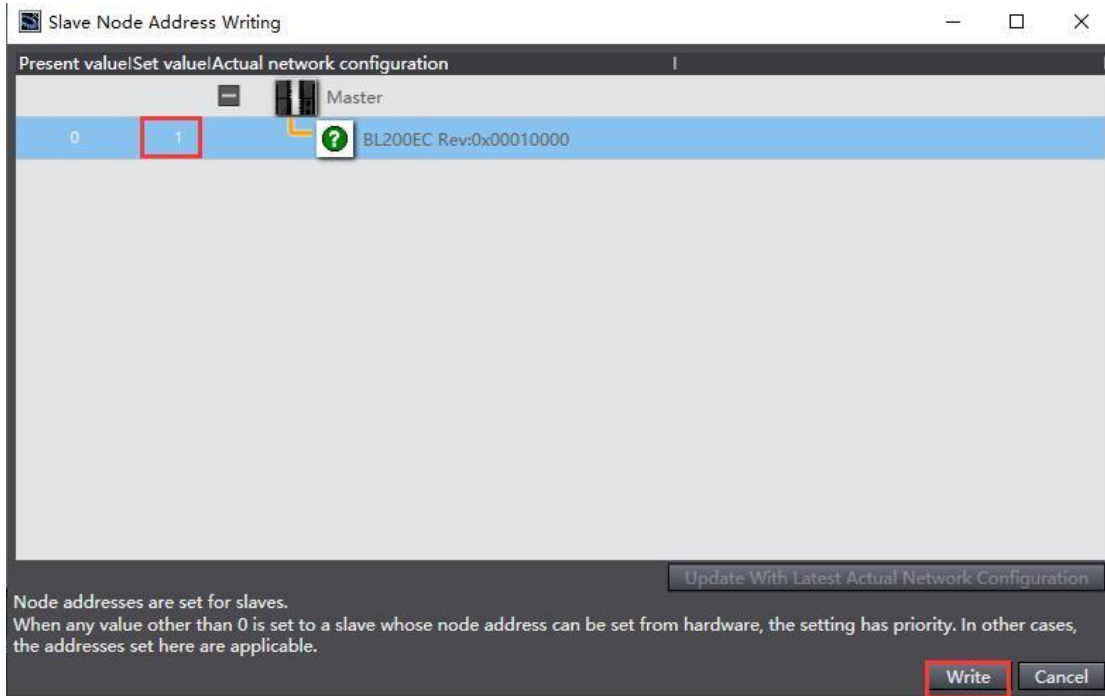

8. Double-click EtherCAT, right-click the master device, and click Compare and Merge with Actual Network Configuration.

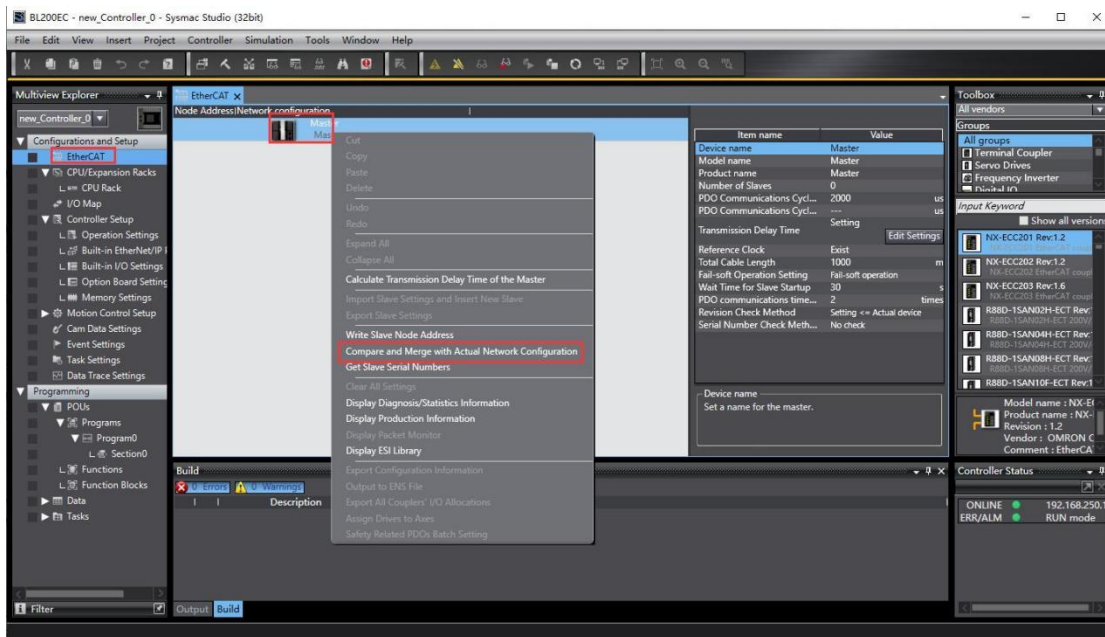

9. In the pop-up window for comparing and merging the same actual network configuration, you can see that a BL202 coupler with a node address of "1" is hung under the master device in the node address actual network configuration column, and in the network setting column on the node address Sysmac Studio, under the master device There is no hanging device. Click Apply Actual Network Configuration, click Apply in the pop-up window, and click Close in the pop-up window, you can see

that the network configuration on Sysmac Studio is the same as the actual network configuration.

Note: Before writing the BL202 node address, you must power off and restart it, otherwise it will prompt that the node address is invalid, you need to rewrite the node address, and then power off and restart. The BL202 does not have an address, and the window for comparing and merging configurations of the same actual network does not pop up.

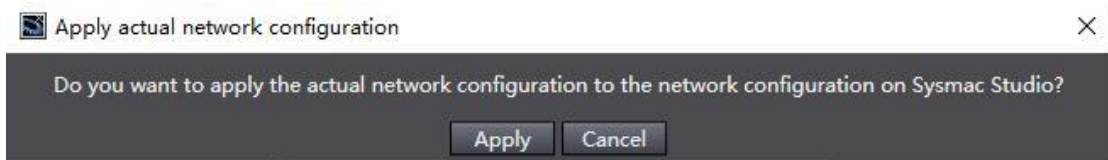
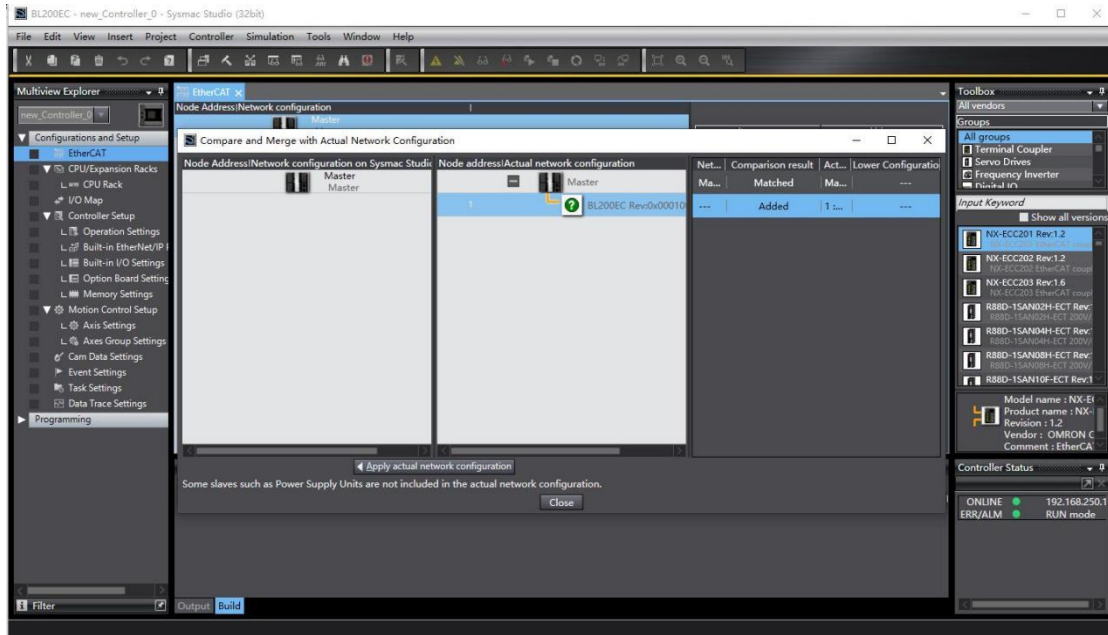

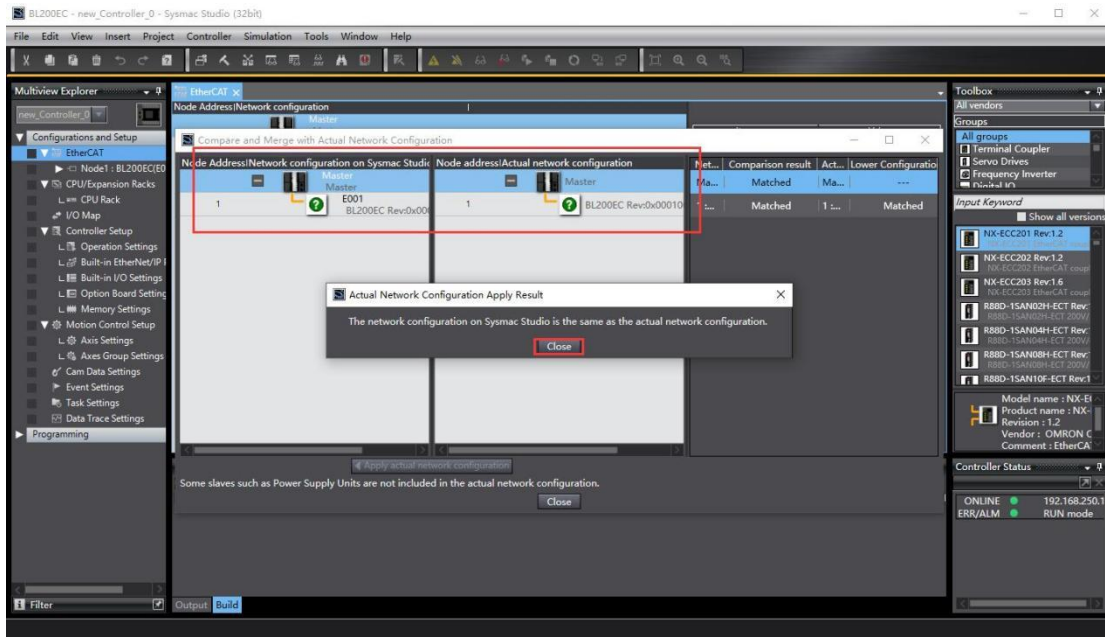

10. Double-click BL202, you can see the I/O module behind BL202. You can also add I/O modules manually, and manually add the PLC when it is offline.

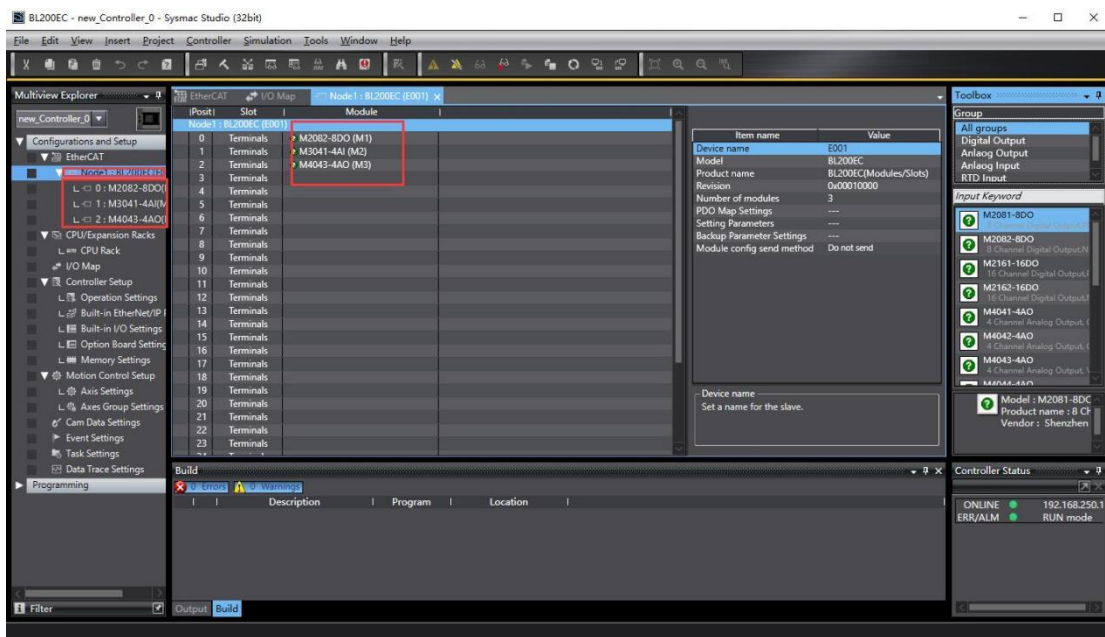

11. Click on the menu bar controller - transfer - transfer to the controller. Click Execute in the pop-up window to download the configuration, settings, and program to the PLC. In the pop-up window, click Yes-Yes-OK.

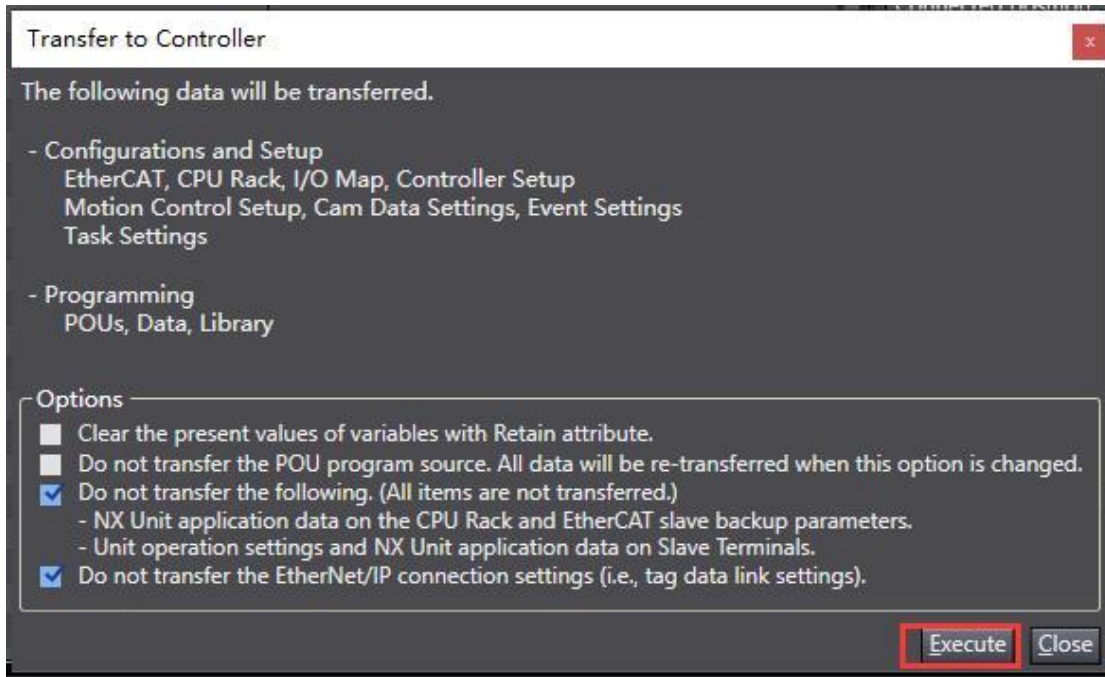
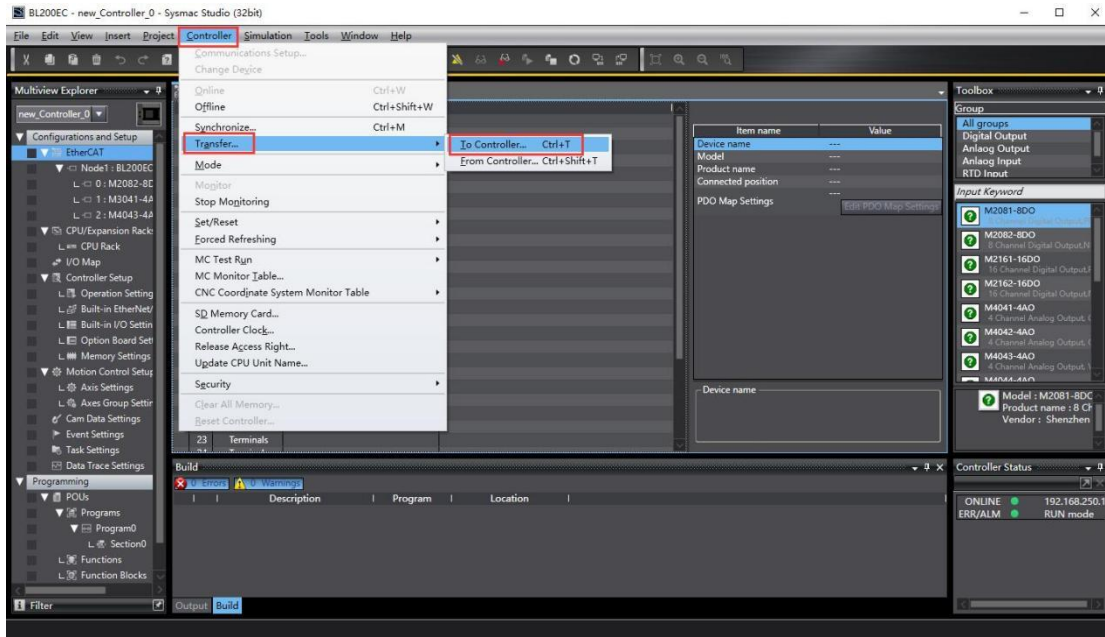

Sysmac Studio

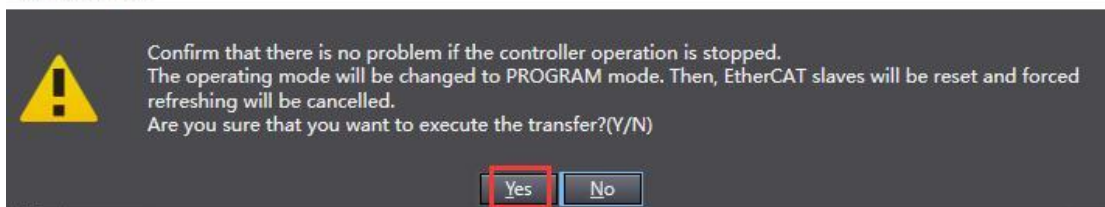

Sysmac Studio

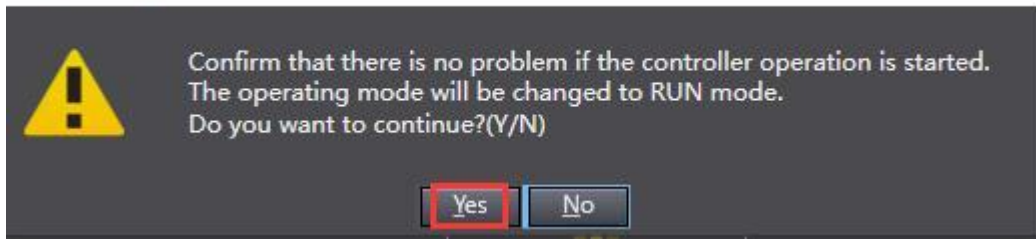

Transfer to Controller

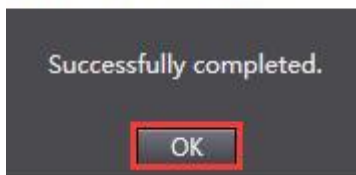

12. Double-click the I/O map, find the DO module M2082, select the channel and right-click Settings/Reset—Setting to set the corresponding channel to 1. Channel 1_7000_01 is set to 1 as shown in the screenshot. Analog output operation is the same as digital output operation.

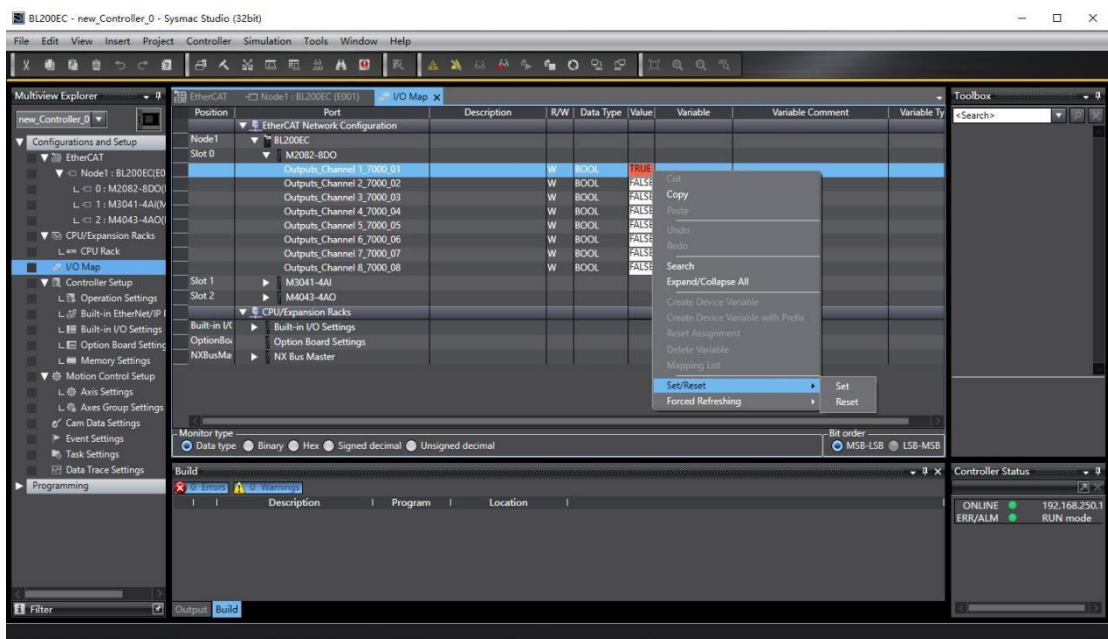

13. View the data of the analog input. Refer to 5.4 Process Data Definition for specific values corresponding to AI.

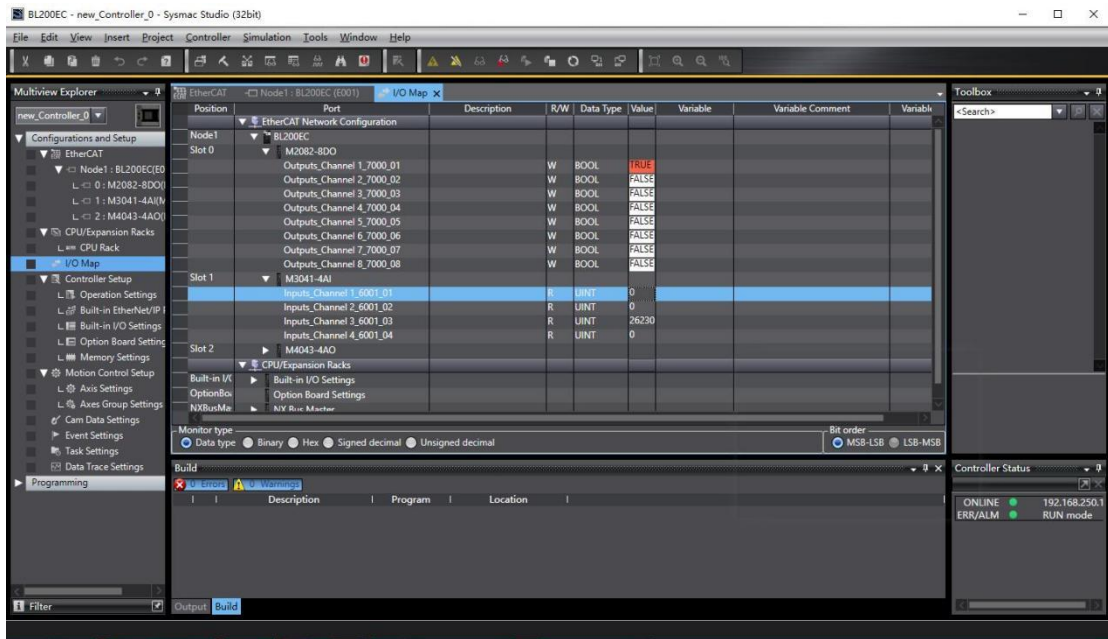

7 Warranty

- 1) This equipment will be repaired free of charge for any material or quality problems within one year from the date of purchase.
- 2) This one-year warranty does not cover any product failure caused by man-made damage, improper operation, etc.

8 Technical Support

Shenzhen Beilai Technology Co., Ltd

Website: <https://www.bliiot.com>